



SSCSBAW56S6 /SSCSBAV70S6 /SSCSBAV99S6

Fast Switching Diode

● Features

- ✧ Fast Switching Speed
- ✧ Ultra-Small Surface Mount Package
- ✧ Low Reverse Leakage Current
- ✧ Ideal for Battery Powered Portable Applications
- ✧ RoHS Compliant/Green EMC
- ✧ Moisture Sensitivity: Level 3 per J-STD-020

● PIN configuration

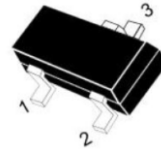

SOT-23

✧ Applications

- ✧ High speed switching for detection
- ✧ Battery Powered Portable
- ✧ Mobile phones, laptops and other electronic devices

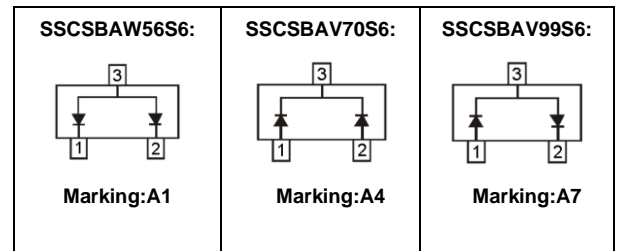

Circuit Diagram

● Absolute maximum rating @T_A=25°C

Parameter	Symbol	Value	Unit
Reverse Voltage(DC)	V _R	70	V
Average Rectified Forward Current	I _{FM}	200	mA
Non-repetitive Peak Forward Surge Current @ t=8.3ms	I _{FSM}	2.0	A
Power Dissipation	P _D	225	mW
Thermal Resistance from Junction to Ambient	R _{θJA}	556	°C/W
Junction Temperature	T _J	125	°C
Storage Temperature	T _{STG}	-55 ~ +150	°C



● **Electrical Characteristics @T_A=25°C**

Parameter	Symbol	Conditions	Min.	Typ.	Max.	Unit
Reverse Voltage	V _R	I _R = 100uA	70			V
Forward Voltage	V _F	I _F = 1mA			0.715	V
		I _F = 10mA			0.855	V
		I _F = 50mA			1	V
		I _F = 150mA			1.25	V
Reverse Current	I _R	V _R = 70V			2.5	μA
Capacitance between terminals	C _T	V _R = 0V, f = 1MHz			1.5	pF
Reverse recovery time	t _{rr}	I _F =I _R =10mA, R _L =100Ω, I _{rr} =0.1I _R			6	ns

● **Typical Performance Characteristics**

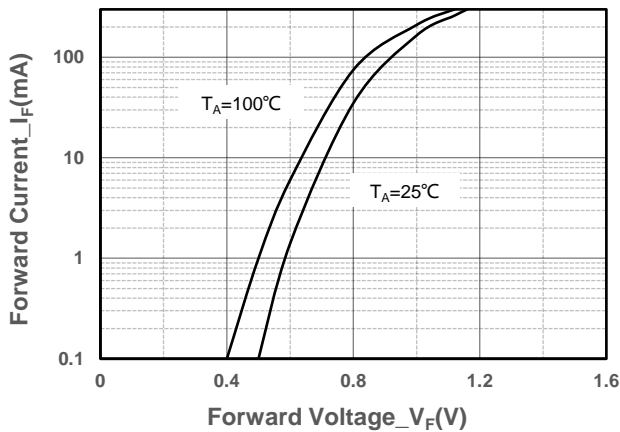

Forward Current vs. Forward Voltage

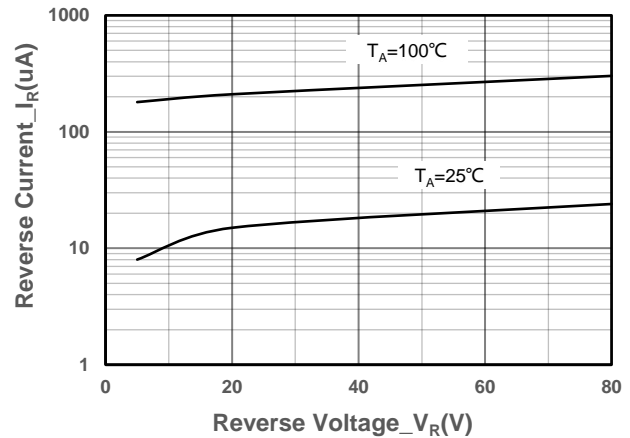

Reverse Current vs. Reverse Voltage

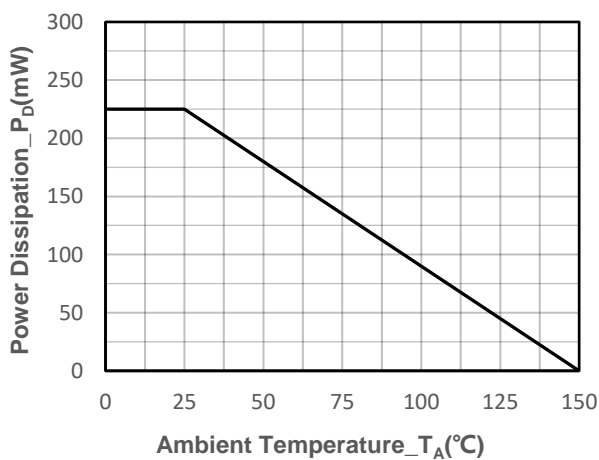

Power Derating vs. Ambient Temperature

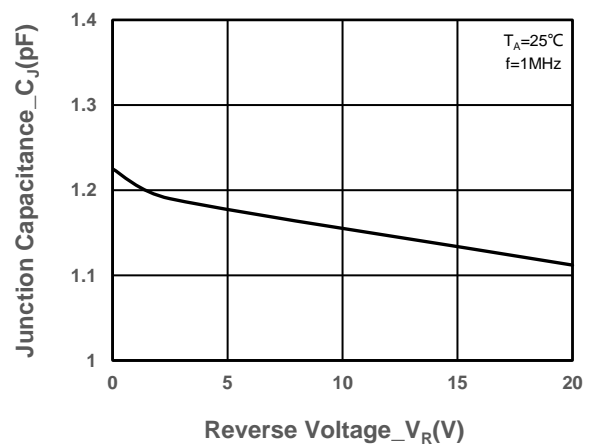

Junction Capacitance vs. Reverse Voltage



SSCSBAW56S6/SSCSBAV70S6 /SSCSBAV99S6

Ordering Information

Device	Package	Marking	Qty per Reel	Reel Size
SSCSBAW56S6	SOT-23	A1	3000	7 Inch
SSCSBAV70S6	SOT-23	A4	3000	7 Inch
SSCSBAV99S6	SOT-23	A7	3000	7 Inch

Mechanical Data

Case: SOT-23

Case Material: Molded Plastic. UL Flammability

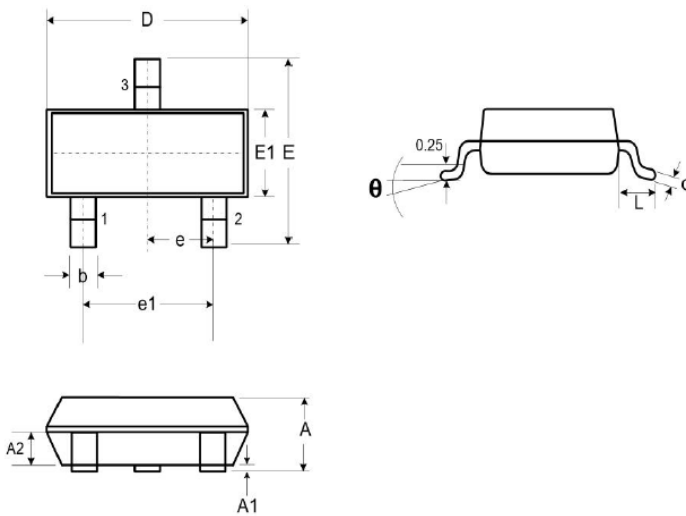

DIM	Millimeters		
	Min.	Typ.	Max.
A	0.89	-	1.12
A1	0.01	-	0.10
A2	0.88	0.95	1.02
b	0.30	-	0.51
c	0.08	-	0.18
D	2.80	2.90	3.04
E	2.10	2.37	2.64
E1	1.20	1.30	1.40
e	1.90		
e1	0.95		
L	0.40	0.50	0.60
L1	0.55		
N	3		
θ	0°	-	8°

Recommended Pad outline(Unit: mm)

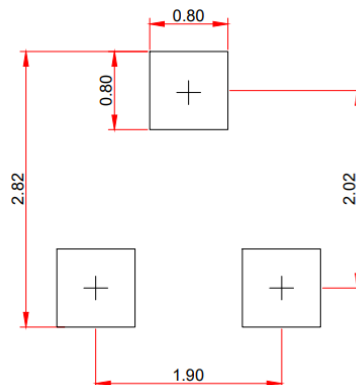

DISCLAIMER



SSCSBAW56S6/SSCSBAV70S6 /SSCSBAV99S6

AFSEMI RESERVES THE RIGHT TO MAKE CHANGES WITHOUT FURTHER NOTICE TO ANY PRODUCTS HEREIN TO IMPROVE RELIABILITY, FUNCTION OR DESIGN. AFSEMI DOES NOT ASSUME ANY LIABILITY ARISING OUT OF THE APPLICATION OR USE OF ANY PRODUCT OR CIRCUIT DESCRIBED HEREIN; NEITHER DOES IT CONVEY ANY LICENCE UNDER ITS PATENT RIGHTS, NOR THE RIGHTS OF OTHERS.

THE GRAPHS PROVIDED IN THIS DOCUMENT ARE STATISTICAL SUMMARIES BASED ON A LIMITED NUMBER OF SAMPLES AND ARE PROVIDED FOR INFORMATIONAL PURPOSE ONLY. THE PERFORMANCE CHARACTERISTICS LISTED IN THEM ARE NOT TESTED OR GUARANTEED. IN SOME GRAPHS, THE DATA PRESENTED MAY BE OUTSIDE THE SPECIFIED OPERATING RANGE (E.G., OUTSIDE SPECIFIED POWER SUPPLY RANGE) AND THEREFORE OUTSIDE THE WARRANTED RANGE.