



SSCSSS52DA THRU SSCSSS520DA

Schottky Barrier Diode

● Features

- ✧ Reverse Voltage - 20 to 200 V
- ✧ Forward Current - 5.0A
- ✧ Low profile package
- ✧ Ideal for automated placement
- ✧ Ultrafast reverse recovery time
- ✧ Low power losses, high efficiency
- ✧ Low forward voltage
- ✧ High surge capability
- ✧ UL Flammability Classification Rating 94V-0
- ✧ High temperature soldering: 260°C/10 seconds at terminals

● PIN configuration

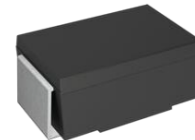

SMA/DO-214AC



Circuit Diagram



Marking

(SS54:SSCSSS54DA Marking Code)

● Applications

- ✧ Low Voltage
- ✧ High-Frequency Inverters
- ✧ Free Wheeling
- ✧ Polarity Protection

● Absolute maximum rating @T_A=25°C

Parameter	Symbol	SS52DA	SS54DA	SS56DA	SS510DA	SS515DA	SS520DA	Unit
Maximum Peak Repetitive Peak Reverse Voltage	V _{RRM}	20	40	60	100	150	200	V
Maximum RMS Voltage	V _{RMS}	14	28	42	70	105	140	V
Maximum DC Blocking Voltage	V _{DC}	20	40	60	100	150	200	V
Maximum Average Forward Rectified Current	I _{F(AV)}	5.0						A
Non-repetitive Peak Forward Surge Current @t=8.3ms	I _{FSM}	100						A
Max Instantaneous Forward Voltage at 3 A	V _F	0.6	0.6	0.75	0.85	0.95	0.95	V
Maximum DC Reverse Current T _a = 25 °C at Rated DC Blocking Voltage T _a =125 °C	I _R	500						μA
		20						mA
Operating Temperature	T _J	-55 ~ +125						°C
Storage Temperature	T _{STG}	-55 ~ +150						°C



● Typical Performance Characteristics

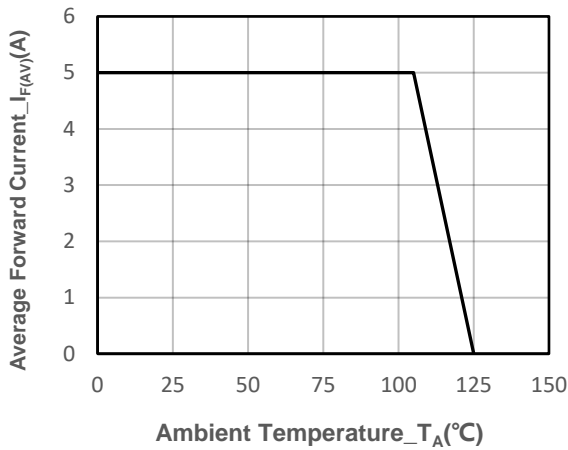

I_o -TL Curve

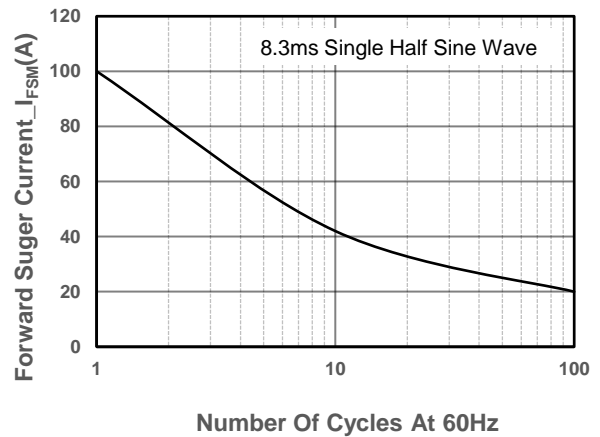

Surge Forward Current Capability Voltage

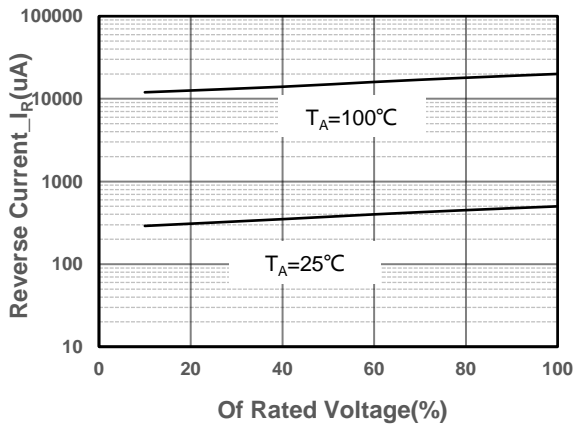

Typical Reverse Characteristics

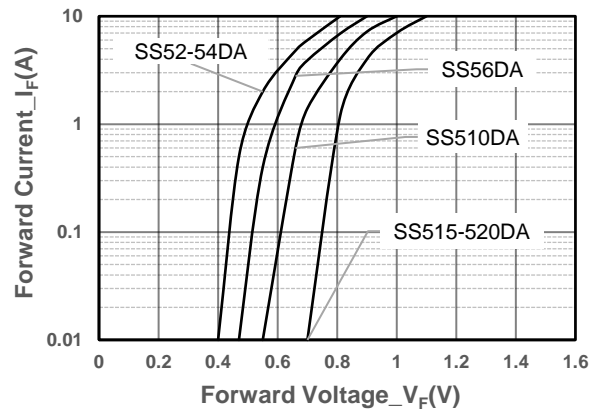

Forward Voltage vs. Forward Current



● Package Information

Ordering Information

Device	Package	Marking	Qty per Reel	Reel diameters
SSCSS52DA	SMA/DO-214AC	SS52	5000	13inch
SSCSS54DA	SMA/DO-214AC	SS54	5000	13inch
SSCSS56DA	SMA/DO-214AC	SS56	5000	13inch
SSCSS510DA	SMA/DO-214AC	SS510	5000	13inch
SSCSS515DA	SMA/DO-214AC	SS515	5000	13inch
SSCSS520DA	SMA/DO-214AC	SS520	5000	13inch

Mechanical Data

Case: SMA/DO-214AC

Case Material: Molded Plastic. UL Flammability

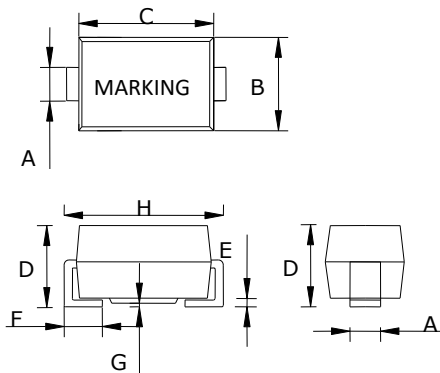

DIM	Millimeters		
	Min	Nom	Max
A	1.40	1.50	1.60
B	2.50	2.67	2.90
C	4.00	4.40	4.50
D	2.00	2.25	2.45
E	0.05	0.200	0.203
F	0.76	1.14	1.52
G	-	-	0.203
H	4.90	5.0	5.30

Recommended Pad outline

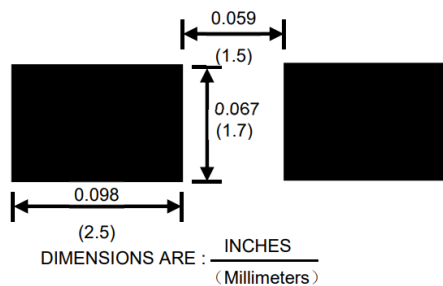



DISCLAIMER

AFSEMI RESERVES THE RIGHT TO MAKE CHANGES WITHOUT FURTHER NOTICE TO ANY PRODUCTS HEREIN TO IMPROVE RELIABILITY, FUNCTION OR DESIGN. AFSEMI DOES NOT ASSUME ANY LIABILITY ARISING OUT OF THE APPLICATION OR USE OF ANY PRODUCT OR CIRCUIT DESCRIBED HEREIN; NEITHER DOES IT CONVEY ANY LICIENCE UNDER ITS PATENT RIGHTS, NOR THE RIGHTS OF OTHERS.

THE GRAPHS PROVIDED IN THIS DOCUMENT ARE STATISTICAL SUMMARIES BASED ON A LIMITED NUMBER OF SAMPLES AND ARE PROVIDED FOR INFORMATIONAL PURPOSE ONLY. THE PERFORMANCE CHARACTERISTICS LISTED IN THEM ARE NOT TESTED OR GUARANTEED. IN SOME GRAPHS, THE DATA PRESENTED MAY BE OUTSIDE THE SPECIFIED OPERATING RANGE (E.G., OUTSIDE SPECIFIED POWER SUPPLY RANGE) AND THEREFORE OUTSIDE THE WARRANTED RANGE.