



SSCEXXX12S6

2-Line Bi-directional TVS Diode

● Description

The SSCEXXX12S6 is a bi-directional TVS diode array, utilizing leading monolithic silicon technology to provide fast response time and low ESD clamping voltage, making this device an ideal solution for protecting sensitive semiconductor components from damage. The SSCEXXX12S6 complies with the IEC 61000-4-2 (ESD) standard with $\pm 30\text{kV}$ air and $\pm 30\text{kV}$ contact discharge.

It is assembled into a lead-free SOT-23 package. It is designed to protect components which are connected to data and transmission lines from voltage surges.

● Features

- ◇ 300W peak pulse power (8/20us)
- ◇ Package: SOT-23
- ◇ Protects two uni-directional line(s)
- ◇ Ultra low leakage: nA level
- ◇ Stand-off Voltage: 3.3 V-36V
- ◇ Ultra low clamping voltage
- ◇ Complies with following standards:
 - IEC61000-4-2(ESD)
 - Air discharge: $\pm 30\text{KV}$
 - Contact discharge: $\pm 30\text{KV}$
 - IEC61000-4-4 (EFT) 40A (5/50ns)
- ◇ RoHS Compliant

● PIN configuration

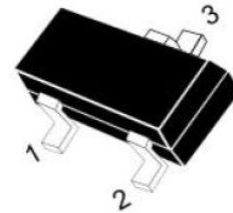

SOT-23(Top view)

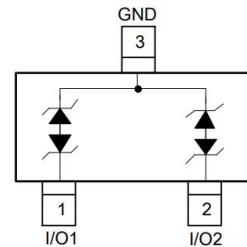

Circuit diagram

● Applications

- ◇ Cellular Handsets and Accessories
- ◇ Personal Digital Assistants
- ◇ Notebooks and Handhelds
- ◇ Portable Instrumentation
- ◇ Set Top Box
- ◇ Industrial Controls
- ◇ Server and Desktop PC

● Mechanical Characteristics

- ◇ Lead finish:100% matte Sn(Tin)
- ◇ Mounting position: Any
- ◇ Qualified max reflow temperature:260°C
- ◇ Device meets MSL 1 requirements
- ◇ Pure tin plating: 7 ~ 17 um



● **Electronic Parameter**

Symbol	Parameter
V_{RWM}	Peak Reverse Working Voltage
I_R	Reverse Leakage Current @ V_{RWM}
V_{BR}	Breakdown Voltage @ I_T
I_T	Test Current
I_{PP}	Maximum Reverse Peak Pulse Current
V_C	Clamping Voltage @ I_{PP}
P_{PP}	Peak Pulse Power
C_J	Junction Capacitance

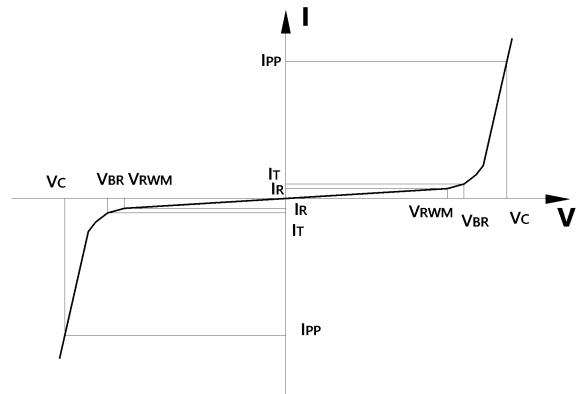

● **Absolute maximum rating @ $T_A=25^{\circ}C$**

SSCE3V312S6			
Symbol	Parameter	Value	Units
P_{PP}	Peak Pulse Power (8/20us)	300	W
I_{PP}	Peak Pulse Current (8/20us)	25	A
V_{ESD}	ESD Rating per IEC61000-4-2: Contact Air	± 30 ± 30	KV
T_{STG}	Storage Temperature	-55/+150	$^{\circ}C$
T_J	Operating Temperature	-55/+125	$^{\circ}C$
SSCE5V012S6			
Symbol	Parameter	Value	Units
P_{PP}	Peak Pulse Power (8/20us)	300	W
I_{PP}	Peak Pulse Current (8/20us)	18	A
V_{ESD}	ESD Rating per IEC61000-4-2: Contact Air	± 30 ± 30	KV
T_{STG}	Storage Temperature	-55/+150	$^{\circ}C$
T_J	Operating Temperature	-55/+125	$^{\circ}C$
SSCE12V12S6			
Symbol	Parameter	Value	Units
P_{PP}	Peak Pulse Power (8/20us)	300	W
I_{PP}	Peak Pulse Current (8/20us)	10	A
V_{ESD}	ESD Rating per IEC61000-4-2: Contact Air	± 30 ± 30	KV
T_{STG}	Storage Temperature	-55/+150	$^{\circ}C$
T_J	Operating Temperature	-55/+125	$^{\circ}C$
SSCE15V12S6			
Symbol	Parameter	Value	Units
P_{PP}	Peak Pulse Power (8/20us)	300	W



SSCEXXX12S6

I _{PP}	Peak Pulse Current (8/20us)		8	A
V _{ESD}	ESD Rating per IEC61000-4-2:	Contact	±30	KV
		Air	±30	
T _{STG}	Storage Temperature		-55/+150	°C
T _J	Operating Temperature		-55/+125	°C
SSCE24V12S6				
Symbol	Parameter		Value	Units
P _{PP}	Peak Pulse Power (8/20us)		300	W
I _{PP}	Peak Pulse Current (8/20us)		5	A
V _{ESD}	ESD Rating per IEC61000-4-2:	Contact	±30	KV
		Air	±30	
T _{STG}	Storage Temperature		-55/+150	°C
T _J	Operating Temperature		-55/+125	°C
SSCE36V12S6				
Symbol	Parameter		Value	Units
P _{PP}	Peak Pulse Power (8/20us)		300	W
I _{PP}	Peak Pulse Current (8/20us)		3	A
V _{ESD}	ESD Rating per IEC61000-4-2:	Contact	±30	KV
		Air	±30	
T _{STG}	Storage Temperature		-55/+150	°C
T _J	Operating Temperature		-55/+125	°C

● Electrical Characteristics @T_A=25°C

SSCE3V312S6						
Parameter	Symbol	Conditions	Min.	Typ.	Max.	Units
Peak Reverse Working Voltage	V _{RWM}				3.3	V
Breakdown Voltage	V _{BR}	I _T =1mA	3.8			V
Reverse Leakage Current	I _R	V _{RWM} =3.3V			1	μA
Clamping Voltage	V _C	I _{PP} =1A, t _P =8/20us		6		V
Clamping Voltage	V _C	I _{PP} =25A, t _P =8/20us			12	V
Junction Capacitance	C _J	V _R =0V, f=1MHz,		100		pF
SSCE5V012S6						
Parameter	Symbol	Conditions	Min.	Typ.	Max.	Units
Peak Reverse Working Voltage	V _{RWM}				5.0	V
Breakdown Voltage	V _{BR}	I _T =1mA	6.0			V
Reverse Leakage Current	I _R	V _{RWM} =5V			1	μA
Clamping Voltage	V _C	I _{PP} =1A, t _P =8/20us		9.8		V
Clamping Voltage	V _C	I _{PP} =18A, t _P =8/20us			16.7	V
Junction Capacitance	C _J	V _R =0V, f=1MHz,		100		pF
SSCE12V12S6						
Parameter	Symbol	Conditions	Min.	Typ.	Max.	Units



SSCEXXX12S6

Peak Reverse Working Voltage	V_{RWM}				12	V
Breakdown Voltage	V_{BR}	$I_T=1mA$	13.3			V
Reverse Leakage Current	I_R	$V_{RWM}=12V$			1	μA
Clamping Voltage	V_C	$I_{PP}=1A, t_P=8/20\mu s$		19		V
Clamping Voltage	V_C	$I_{PP}=10A, t_P=8/20\mu s$			30	V
Junction Capacitance	C_J	$V_R=0V, f=1MHz,$		60		pF

SSCE15V12S6

Parameter	Symbol	Conditions	Min.	Typ.	Max.	Units
Peak Reverse Working Voltage	V_{RWM}				15	V
Breakdown Voltage	V_{BR}	$I_T=1mA$	16.7			V
Reverse Leakage Current	I_R	$V_{RWM}=15V$			1	μA
Clamping Voltage	V_C	$I_{PP}=1A, t_P=8/20\mu s$		24		V
Clamping Voltage	V_C	$I_{PP}=8A, t_P=8/20\mu s$			38.5	V
Junction Capacitance	C_J	$V_R=0V, f=1MHz,$		55		pF

SSCE24V12S6

Parameter	Symbol	Conditions	Min.	Typ.	Max.	Units
Peak Reverse Working Voltage	V_{RWM}				24	V
Breakdown Voltage	V_{BR}	$I_T=1mA$	26.7			V
Reverse Leakage Current	I_R	$V_{RWM}=24V$			1	μA
Clamping Voltage	V_C	$I_{PP}=1A, t_P=8/20\mu s$		35		V
Clamping Voltage	V_C	$I_{PP}=5A, t_P=8/20\mu s$			65	V
Junction Capacitance	C_J	$V_R=0V, f=1MHz,$		36		pF

SSCE36V12S6

Parameter	Symbol	Conditions	Min.	Typ.	Max.	Units
Peak Reverse Working Voltage	V_{RWM}				36	V
Breakdown Voltage	V_{BR}	$I_T=1mA$	40			V
Reverse Leakage Current	I_R	$V_{RWM}=36V$			1	μA
Clamping Voltage	V_C	$I_{PP}=1A, t_P=8/20\mu s$		60		V
Clamping Voltage	V_C	$I_{PP}=3A, t_P=8/20\mu s$			75	V
Junction Capacitance	C_J	$V_R=0V, f=1MHz,$		30		pF



● Typical Performance Characteristics($T_A=25^{\circ}\text{C}$ unless otherwise Specified)

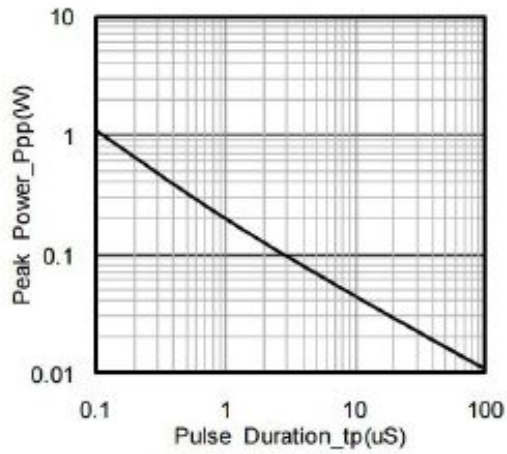

Peak Pulse Power vs. Pulse Time

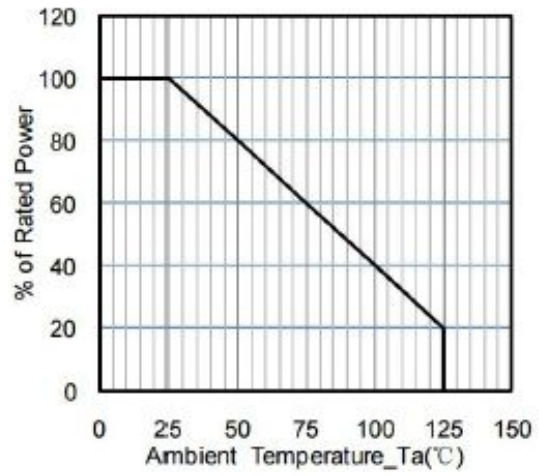

Power Derating Curve

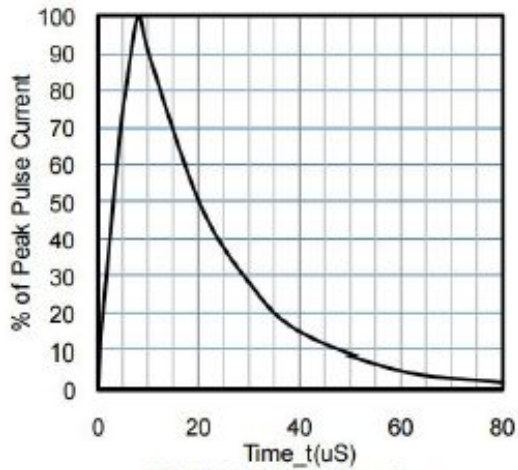

8 X 20uS Pulse Waveform



● **Package Information**

Ordering Information

Device	Package	Qty per Reel	Reel Size
SSCEXXX12S6	SOT-23	3000	7 Inch

Mechanical Data

Case: SOT-23

Case Material: Molded Plastic. UL Flammability

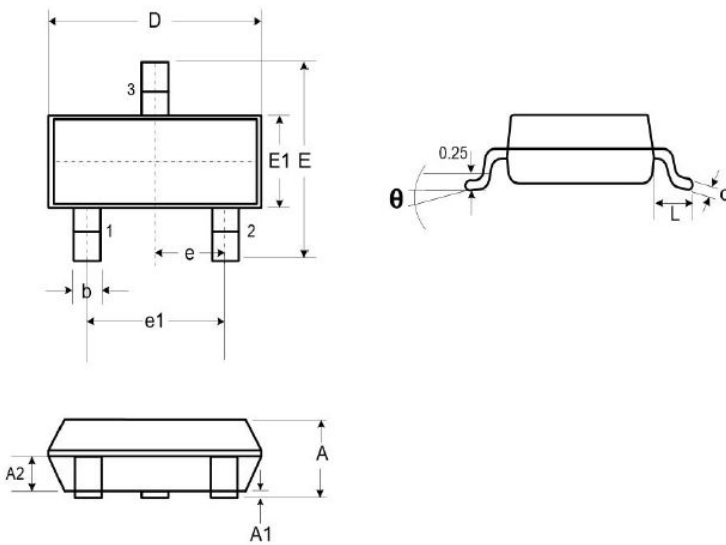

DIM	Millimeters		
	Min.	Typ.	Max.
A	0.89	-	1.12
A1	0.01	-	0.10
A2	0.88	0.95	1.02
b	0.30	-	0.51
c	0.08	-	0.18
D	2.80	2.90	3.04
E	2.10	2.37	2.64
E1	1.20	1.30	1.40
e	1.90		
e1	0.95		
L	0.40	0.50	0.60
L1	0.55		
N	3		
θ	0°	-	8°

Recommended Pad outline(Unit: mm)

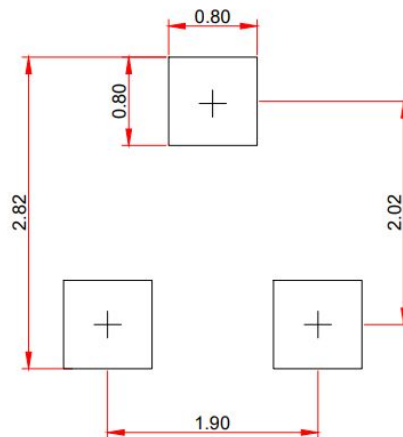



- **History Version**

V1.0	First edition	2021-08-03
------	---------------	------------

DISCLAIMER

AF SEMI RESERVES THE RIGHT TO MAKE CHANGES WITHOUT FURTHER NOTICE TO ANY PRODUCTS HEREIN TO IMPROVE RELIABILITY, FUNCTION OR DESIGN. AF SEMI DOES NOT ASSUME ANY LIABILITY ARISING OUT OF THE APPLICATION OR USE OF ANY PRODUCT OR CIRCUIT DESCRIBED HEREIN; NEITHER DOES IT CONVEY ANY LICIENCE UNDER ITS PATENT RIGHTS, NOR THE RIGHTS OF OTHERS.

THE GRAPHS PROVIDED IN THIS DOCUMENT ARE STATISTICAL SUMMARIES BASED ON A LIMITED NUMBER OF SAMPLES AND ARE PROVIDED FOR INFORMATIONAL PURPOSE ONLY. THE PERFORMANCE CHARACTERISTICS LISTED IN THEM ARE NOT TESTED OR GUARANTEED. IN SOME GRAPHS, THE DATA PRESENTED MAY BE OUTSIDE THE SPECIFIED OPERATING RANGE (E.G., OUTSIDE SPECIFIED POWER SUPPLY RANGE) AND THEREFORE OUTSIDE THE WARRANTED RANGE.