



## SSCN3904GS6

### NPN Switching Transistor

#### ➤ Features

VCE	VBE	VCEsat	IC
40V	6V	300mV	200mA

#### ➤ Description

The NPN Transistor is designed for use in linear and switching applications. The device is housed in the SOT-23 package, which is designed for telephony and professional communication equipment.

#### ➤ Applications

- General purpose switching and amplification
- Telephony and professional communication equipment

#### ➤ Ordering Information

Device	Package	Shipping
SSCN3904GS6	SOT-23	3000/Reel

#### ➤ Pin configuration



**SOT-23**

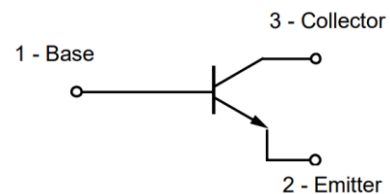

**Circuit Diagram**

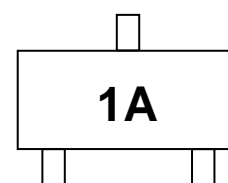

**Marking(Top View)**



➤ **Absolute Maximum Ratings**( $T_A=25^{\circ}\text{C}$  unless otherwise noted)

Parameter	Symbol	Value	Unit
Collector-Base Voltage	$V_{CB0}$	60	V
Collector- Emitter Voltage	$V_{CEO}$	40	V
Emitter-Base Voltage	$V_{EBO}$	6	V
Collector Current-Continuous	$I_C$	200	mA
Collector Power Dissipation	$P_C$	200	mW
Junction Temperature	$T_J$	150	$^{\circ}\text{C}$
Storage Temperature	$T_{STG}$	-55 to 150	$^{\circ}\text{C}$

➤ **Electrical Characteristics** ( $T_A=25^{\circ}\text{C}$  unless otherwise noted)

Parameter	Symbol	Test Conditions	Min.	Typ.	Max.	Unit
Collector-Base Breakdown Voltage	$BV_{CB0}$	$I_C=10\mu\text{A}, I_E=0$	60			V
Collector-emitter Breakdown Voltage	$BV_{CEO}$	$I_C=1\text{mA}, I_B=0$	40			V
Emitter -Base Breakdown Voltage	$BV_{EBO}$	$I_E=10\mu\text{A}, I_C=0$	6			V
Collector Cutoff Current	$I_{CEX}$	$V_{CE}=30\text{V}, V_{EB}=3\text{V}$			50	nA
Collector Cutoff Current	$I_{CBO}$	$V_{CB}=30\text{V}, I_E=0$			100	nA
Emitter Cutoff Current	$I_{EBO}$	$V_{EB}=3\text{V}, I_C=0$			100	nA
DC Current Gain	$h_{FE}$	$V_{CE}=1\text{V}, I_C=10\text{mA}$	100		300	
		$V_{CE}=1\text{V}, I_C=0.1\text{mA}$	40			
		$V_{CE}=1\text{V}, I_C=100\text{mA}$	30			
Collector-Emitter Saturation Voltage	$V_{CE(sat)}$	$I_C=50\text{mA}, I_B=5\text{mA}$			0.3	V
Base-Emitter Saturation Voltage	$V_{BE(sat)}$	$I_C=50\text{mA}, I_B=5\text{mA}$			0.95	V
Transition frequency	$f_T$	$V_{CE}=20\text{V}, I_C=10\text{mA}$ $f=100\text{MHz}$	250			MHz
Delay Time	$t_d$	$V_{CC}=3\text{V}, V_{BE(off)}=-0.5\text{V}$ $I_C=10\text{mA}, I_{B1}=1\text{mA}$			35	ns
Rise Time	$t_r$	$V_{CC}=3\text{V}, V_{BE(off)}=-0.5\text{V}$ $I_C=10\text{mA}, I_{B1}=1\text{mA}$			35	ns
Storage Time	$t_s$	$V_{CC}=3\text{V}, I_C=10\text{mA}$ $I_{B1}=I_{B2}=1\text{mA}$			200	ns
Fall Time	$t_f$	$V_{CC}=3\text{V}, I_C=10\text{mA}$ $I_{B1}=I_{B2}=1\text{mA}$			50	ns



➤ Typical Performance Characteristics ( $T_A=25^\circ\text{C}$  unless otherwise noted)

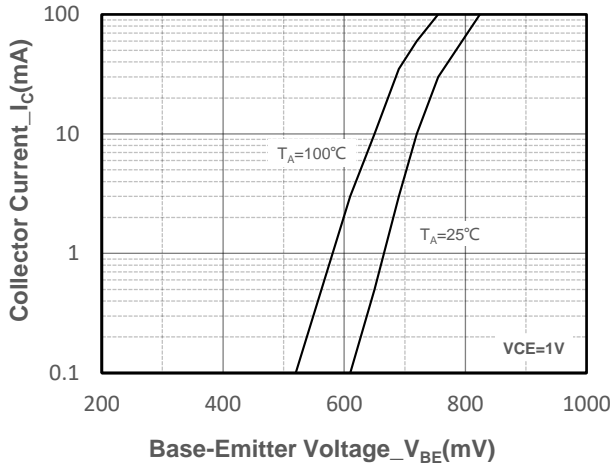

Collector Current vs. Base-Emitter Voltage

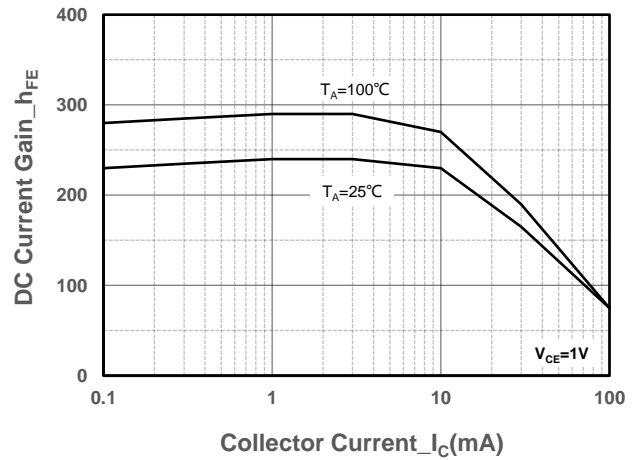

DC Current Gain vs. Collector Current

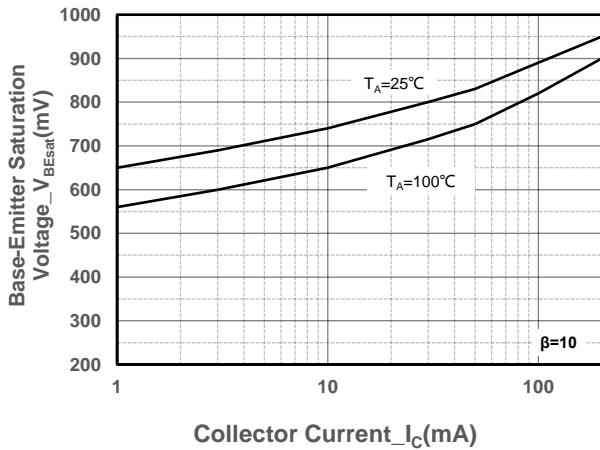

$V_{BE(sat)}$  vs. Collector Current

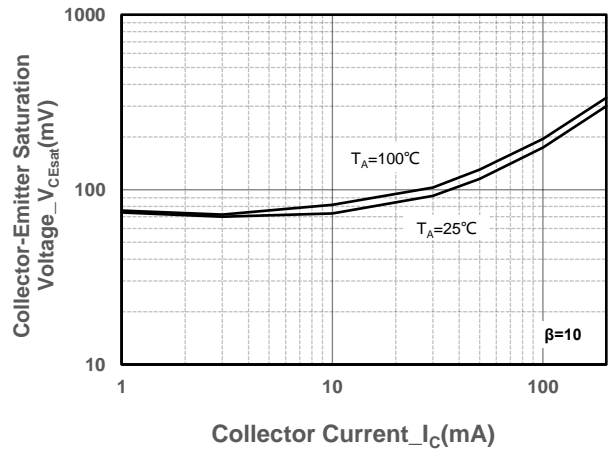

$V_{CE(sat)}$  vs. Collector Current

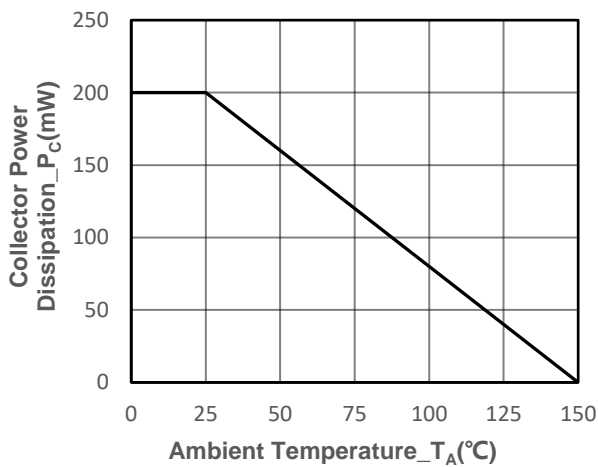

Power derating vs. Ambient temperature

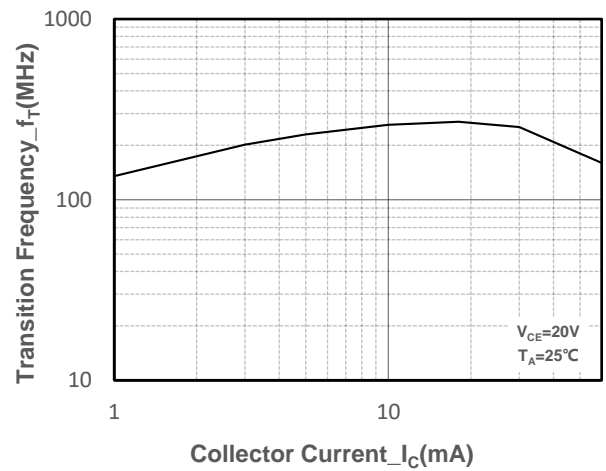

Transition Frequency vs. Collector Current



● **Package Information**

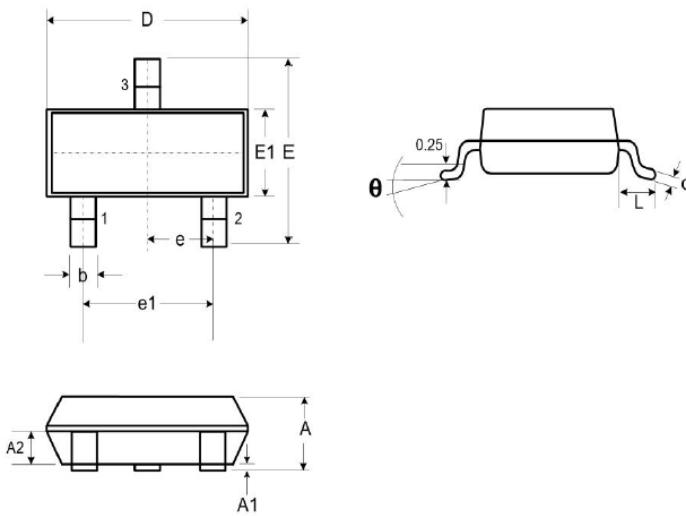

DIM	Millimeters		
	Min.	Typ.	Max.
A	0.89	-	1.12
A1	0.01	-	0.10
A2	0.88	0.95	1.02
b	0.30	-	0.51
c	0.08	-	0.18
D	2.80	2.90	3.04
E	2.10	2.37	2.64
E1	1.20	1.30	1.40
e	1.90		
e1	0.95		
L	0.40	0.50	0.60
L1	0.55		
N	3		
θ	0°	-	8°

**Recommended Pad outline(Unit: mm)**

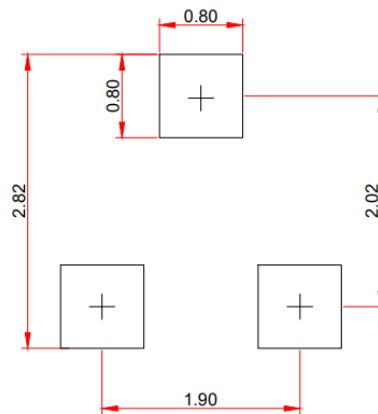



## DISCLAIMER

AFSEMI RESERVES THE RIGHT TO MAKE CHANGES WITHOUT FURTHER NOTICE TO ANY PRODUCTS HEREIN TO IMPROVE RELIABILITY, FUNCTION OR DESIGN. AFSEMI DOES NOT ASSUME ANY LIABILITY ARISING OUT OF THE APPLICATION OR USE OF ANY PRODUCT OR CIRCUIT DESCRIBED HEREIN; NEITHER DOES IT CONVEY ANY LICIENCE UNDER ITS PATENT RIGHTS, NOR THE RIGHTS OF OTHERS.

THE GRAPHS PROVIDED IN THIS DOCUMENT ARE STATISTICAL SUMMARIES BASED ON A LIMITED NUMBER OF SAMPLES AND ARE PROVIDED FOR INFORMATIONAL PURPOSE ONLY. THE PERFORMANCE CHARACTERISTICS LISTED IN THEM ARE NOT TESTED OR GUARANTEED. IN SOME GRAPHS, THE DATA PRESENTED MAY BE OUTSIDE THE SPECIFIED OPERATING RANGE (E.G., OUTSIDE SPECIFIED POWER SUPPLY RANGE ) AND THEREFORE OUTSIDE THE WARRANTED RANGE.