



## SSCT4V512L2

### 1-Line High Power TVS Diode

#### ● Description

The SSCT4V512L2 is a high power TVS, utilizing leading monolithic silicon technology to provide fast response time and low ESD clamping voltage, making this device an ideal solution for protecting voltage sensitive lines. The SSCT4V512L2 complies with the IEC61000-4-2 (ESD) standard with  $\pm 30\text{kV}$  air and  $\pm 30\text{kV}$  contact discharge. It is assembled into a 3-pin DFN2020-3L package. The leads are finished with NiPdAu. Each device will protect one line. The combination of small size, and high surge capability makes them ideal for use in applications such as cellular phones, LCD displays, USB, and multimedia card interfaces.

#### ● Feature

- ✧ 2200W peak pulse power ( $t_p = 8/20\mu\text{s}$ )
- ✧ DFN2020-3L Package
- ✧ Working voltage: 4.5V
- ✧ Low clamping voltage
- ✧ Low leakage current
- ✧ RoHS compliant transient protection for high speed data lines to IEC61000-4-2(ESD) $\pm 30\text{kV}$ (air), $\pm 30\text{kV}$ (contact)

#### ● PIN configuration

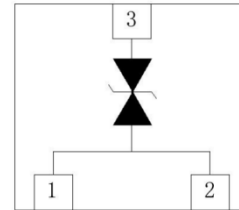

**Top view**

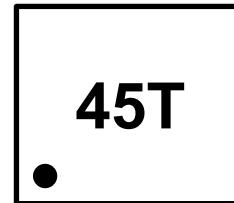

**Marking**

#### ● Applications

- ✧ DVI & HDMI Port Protection
- ✧ Serial and Parallel Ports
- ✧ Projection TV
- ✧ Notebooks, Desktops, Server
- ✧ Power supply protection
- ✧ Power management

#### ● Mechanical data

- ✧ Lead finish: 100% matte Sn(Tin)
- ✧ Mounting position: Any
- ✧ Qualified max reflow temperature:  $260^\circ\text{C}$
- ✧ Device meets MSL 3 requirements
- ✧ Pure tin plating: 7 ~ 17  $\mu\text{m}$



● **Electronic Parameter**

Symbol	Parameter
$V_{RWM}$	Peak Reverse Working Voltage
$I_R$	Reverse Leakage Current @ $V_{RWM}$
$V_{BR}$	Breakdown Voltage @ $I_T$
$I_T$	Test Current
$I_{PP}$	Maximum Reverse Peak Pulse Current
$V_C$	Clamping Voltage @ $I_{PP}$
$P_{PP}$	Peak Pulse Power
$C_J$	Junction Capacitance

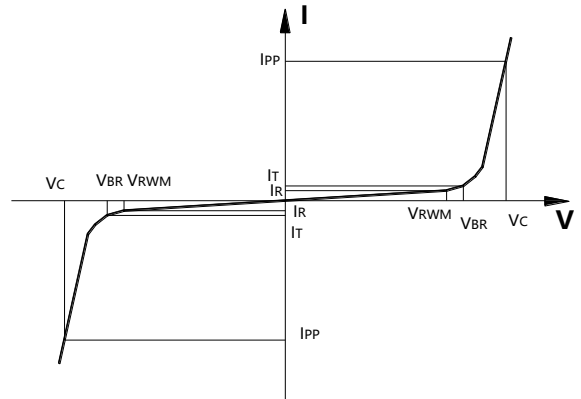

● **Absolute maximum rating @TA=25°C**

Parameter	Symbol	Value	Unit
Peak Pulse Power (8/20μs)	$P_{PP}$	2200	W
Peak Pulse Current (8/20μs)	$I_{PP}$	160	A
ESD Rating per IEC61000-4-2:	$V_{ESD}$	Contact	30
		Air	30
Storage Temperature	$T_{STG}$	-55/+150	°C
Operating Temperature	$T_J$	-55/+125	°C

● **Electrical Characteristics @TA=25°C**

Parameter	Symbol	Conditions	Min.	Typ.	Max.	Unit
Peak Reverse Working Voltage	$V_{RWM}$				4.5	V
Breakdown Voltage	$V_{BR}$	$I_T = 1mA$	5			V
Reverse Leakage Current	$I_R$	$V_{RWM} = 4.5V$			1	μA
Clamping Voltage	$V_C$	$I_{PP} = 50A, t_p = 8/20us$		9		V
Clamping Voltage	$V_C$	$I_{PP} = 160A, t_p = 8/20us$		17		V
Junction Capacitance	$C_J$	$V_R = 0V, f = 1MHz$		250		pF



## ● Typical Performance Characteristics

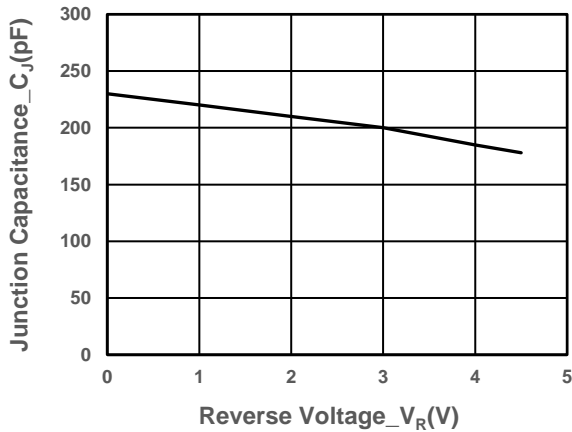

**Junction Capacitance vs. Reverse Voltage**

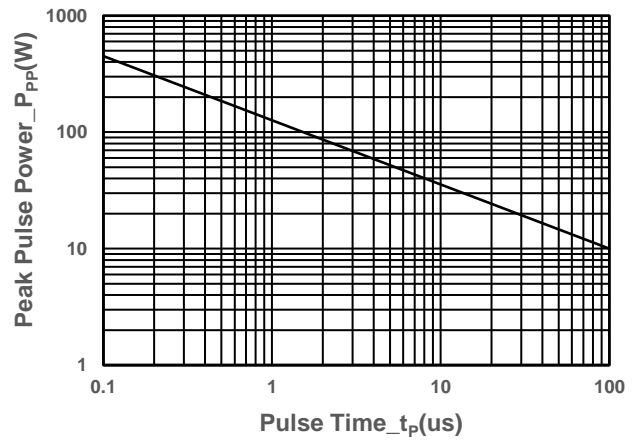

**Peak Pulse Power vs. Pulse Time**

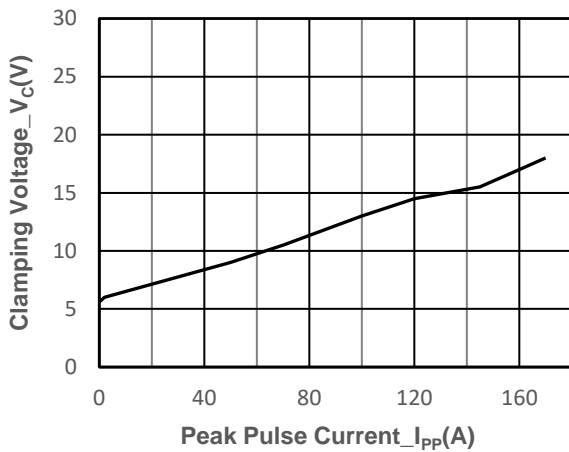

**Clamping Voltage vs. Peak Pulse Current**

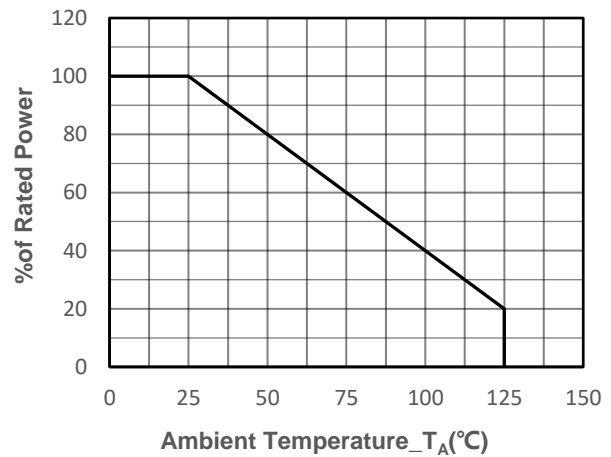

**Power derating vs. Ambient temperature**

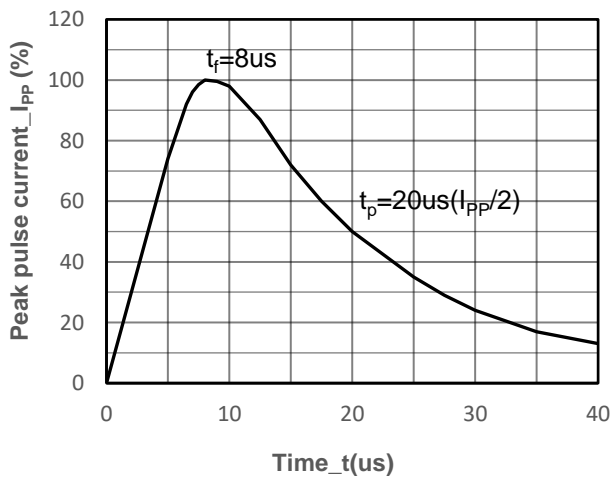

**8/20us Pulse Waveform**



- **Package Information**

## Ordering Information

Device	Package	Qty per Reel	Reel Size
SSCT4V512L2	DFN2020-3L	3000	7 Inch

## Mechanical Data

Case:DFN2020-3L

Case Material: Molded Plastic. UL Flammability

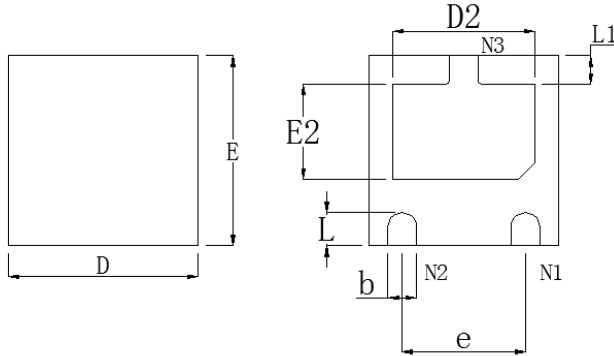

DIM	Millimeters		
	Min.	Nom.	Max.
A	0.50	0.55	0.60
A1	0.00	-	0.05
A3	0.15 REF.		
D	1.95	2.00	2.05
E	1.95	2.00	2.05
b	0.25	0.30	0.35
L	0.30	0.35	0.40
L1	0.25	0.30	0.35
D2	1.35	1.50	1.60
E2	0.85	1.00	1.10
e	1.30 BSC		

## Recommended Pad outline

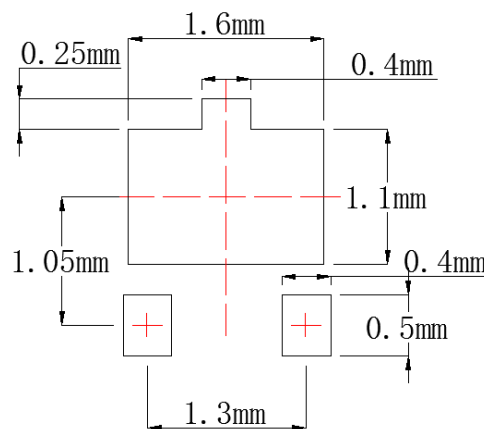



- **History Version**

V2.0	First edition	2019-06-08
V2.1	1.Add marking Icon 2.Update typical performance characteristics 3.Update Electrical Characteristics	2022-07-26

## DISCLAIMER

AFSEMI RESERVES THE RIGHT TO MAKE CHANGES WITHOUT FURTHER NOTICE TO ANY PRODUCTS HEREIN TO IMPROVE RELIABILITY, FUNCTION OR DESIGN. AFSEMI DOES NOT ASSUME ANY LIABILITY ARISING OUT OF THE APPLICATION OR USE OF ANY PRODUCT OR CIRCUIT DESCRIBED HEREIN; NEITHER DOES IT CONVEY ANY LICIENCE UNDER ITS PATENT RIGHTS, NOR THE RIGHTS OF OTHERS.

THE GRAPHS PROVIDED IN THIS DOCUMENT ARE STATISTICAL SUMMARIES BASED ON A LIMITED NUMBER OF SAMPLES AND ARE PROVIDED FOR INFORMATIONAL PURPOSE ONLY. THE PERFORMANCE CHARACTERISTICS LISTED IN THEM ARE NOT TESTED OR GUARANTEED. IN SOME GRAPHS, THE DATA PRESENTED MAY BE OUTSIDE THE SPECIFIED OPERATING RANGE (E.G., OUTSIDE SPECIFIED POWER SUPPLY RANGE ) AND THEREFORE OUTSIDE THE WARRANTED RANGE.