



## SSC8034GS6

### N-Channel Enhancement Mode MOSFET

#### ➤ Features

VDS	VGS	RDSON Typ.	ID
30V	±12V	18mR@10V	7A
		20mR@4V5	
		30mR@2V5	

#### ➤ Description

This device uses advanced trench technology to provide excellent RDSON and low gate charge and operation with gate voltages as low as 2.5V. This device is suitable for use as a load switch or in PWM applications.

#### ➤ Applications

- Load Switch
- Portable Devices
- DCDC conversion

#### ➤ Ordering Information

Device	Package	Shipping
SSC8034GS6	SOT23	3000/Reel

#### ➤ Pin configuration

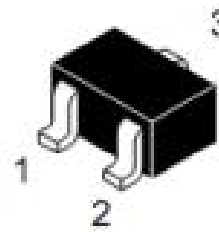
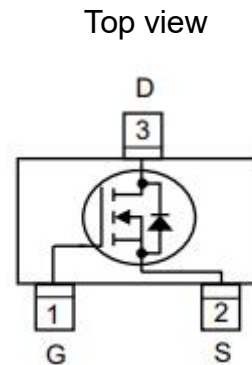

SOT23

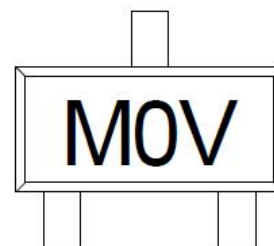

Marking



➤ **Absolute Maximum Ratings**( $T_A=25^{\circ}\text{C}$  unless otherwise noted)

Symbol	Parameter	Ratings	Unit
$V_{DSS}$	Drain-to-Source Voltage	30	V
$V_{GSS}$	Gate-to-Source Voltage	$\pm 12$	V
$I_D$	Continuous Drain Current <sup>a</sup>	7	A
$I_{DM}$	Pulsed Drain Current <sup>b</sup>	30	A
$P_D$	Power Dissipation <sup>c</sup>	1.7	W
$P_{DSM}$	Power Dissipation <sup>a</sup>	0.85	W
$T_J$	Operation junction temperature	-55 to 150	$^{\circ}\text{C}$
$T_{STG}$	Storage temperature range	-55 to 150	$^{\circ}\text{C}$

➤ **Thermal Resistance Ratings**( $T_A=25^{\circ}\text{C}$  unless otherwise noted)

Symbol	Parameter	Typical	Maximum	Unit
$R_{\theta JA}$	Junction-to-Ambient Thermal Resistance <sup>a</sup>		155	$^{\circ}\text{C}/\text{W}$
$R_{\theta JC}$	Junction-to-Case Thermal Resistance		80	

Note:

- The value of  $R_{\theta JA}$  is measured with the device mounted on 1 in<sup>2</sup> FR-4 board with 2oz.copper, in a still air environment with  $T_A=25^{\circ}\text{C}$ . The value in any given application depends on the user is specific board design. The current rating is based on the  $t \leq 10\text{s}$  thermal resistance rating.
- Repetitive rating, pulse width limited by junction temperature.
- The power dissipation  $P_D$  is based on  $T_{J(MAX)}=150^{\circ}\text{C}$ , using junction-to-case thermal resistance, and is more useful in setting the upper dissipation limit for cases where additional heat sinking is used.



➤ **Electronics Characteristics**( $T_A=25^{\circ}\text{C}$  unless otherwise noted)

Symbol	Parameter	Test Conditions	Min	Typ.	Max	Unit
$V_{(BR)DSS}$	Drain-Source Breakdown Voltage	$V_{GS}=0V, I_D=250\mu A$	30			V
$V_{GS(th)}$	Gate Threshold Voltage	$V_{DS}=V_{GS}, I_D=250\mu A$	0.6	0.8	1.2	V
$R_{DS(on)}$	Drain-Source On-Resistance	$V_{GS}=10V, I_D=5.8A$		18	25	mR
		$V_{GS}=4.5V, I_D=5A$		20	30	
		$V_{GS}=2.5V, I_D=4A$		30	50	
$I_{DSS}$	Zero Gate Voltage Drain Current	$V_{DS}=24V, V_{GS}=0V$			1	$\mu A$
$I_{GSS}$	Gate-Source leak current	$V_{GS}=\pm 12V, V_{DS}=0V$			$\pm 100$	nA
$G_{FS}$	Transconductance	$V_{DS}=5V, I_D=5A$		10		S
$V_{SD}$	Forward Voltage	$V_{GS}=0V, I_S=1.1A$		0.7	1.5	V
$C_{iss}$	Input Capacitance	$V_{DS}=10V, V_{GS}=0V, f=1MHz$		697		pF
$C_{oss}$	Output Capacitance			259		
$C_{rss}$	Reverse Transfer Capacitance			308		
$T_{D(ON)}$	Turn-on delay time	$V_{GS}=10V,$ $V_{DS}=15V, R_G=3R, R_L=2.3R$		18		ns
$T_r$	Rise Time			9		
$T_{D(OFF)}$	Turn-off delay time			70		
$T_f$	Fall Time			22		
$Q_g$	Total Gate charge	$V_{GS}=4.5V, V_{DS}=10V, I_D=4A$		9		nC
$Q_{gs}$	Gate to Source charge			2		
$Q_{gd}$	Gate to Drain charge			2.3		



➤ **Typical Characteristics** ( $T_A=25^\circ\text{C}$  unless otherwise noted)

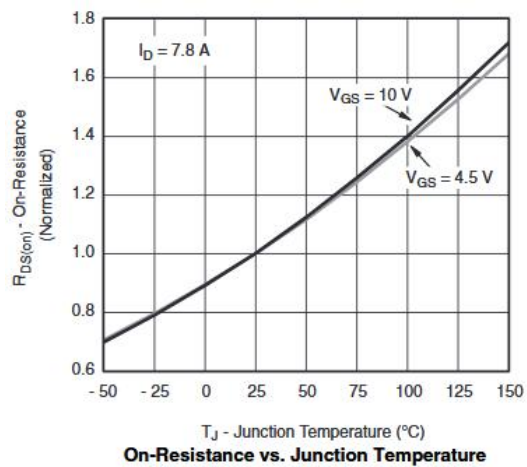
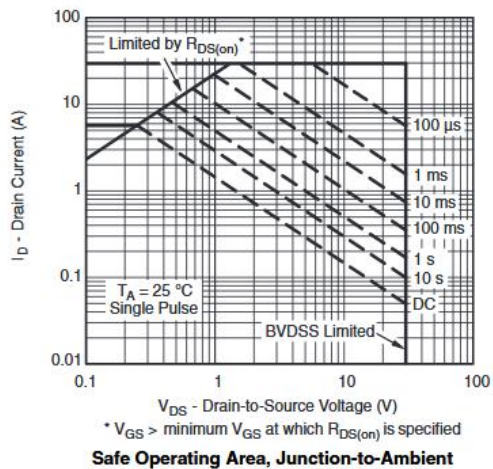
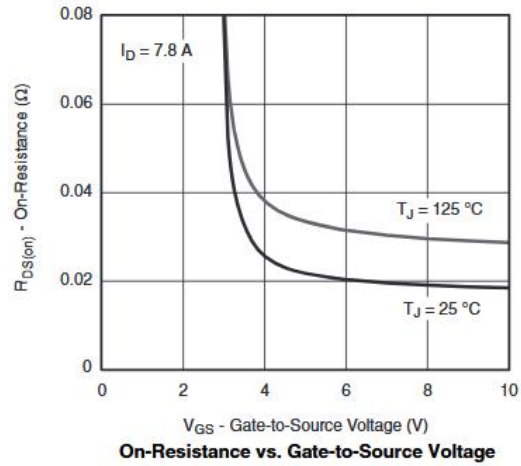
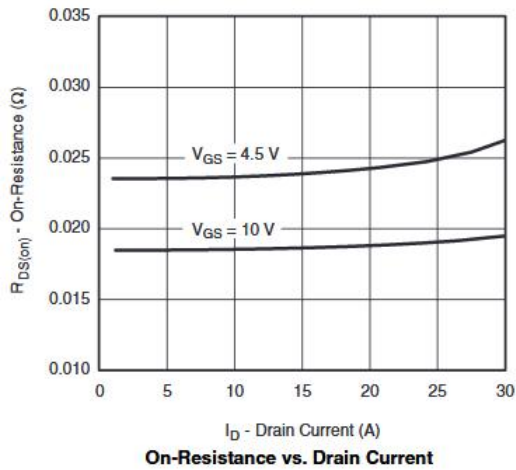
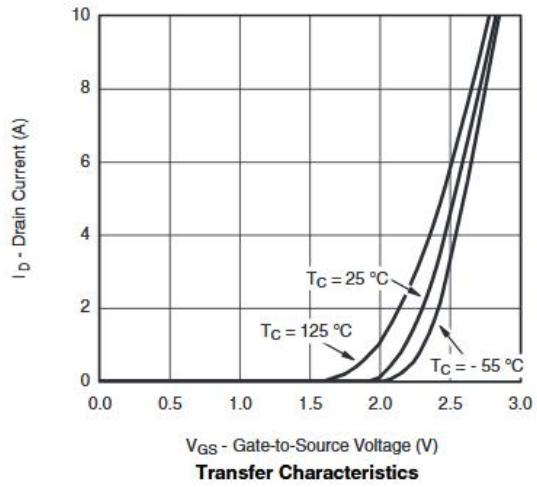
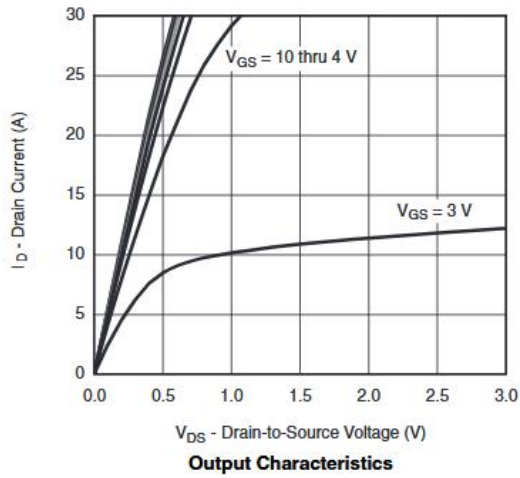

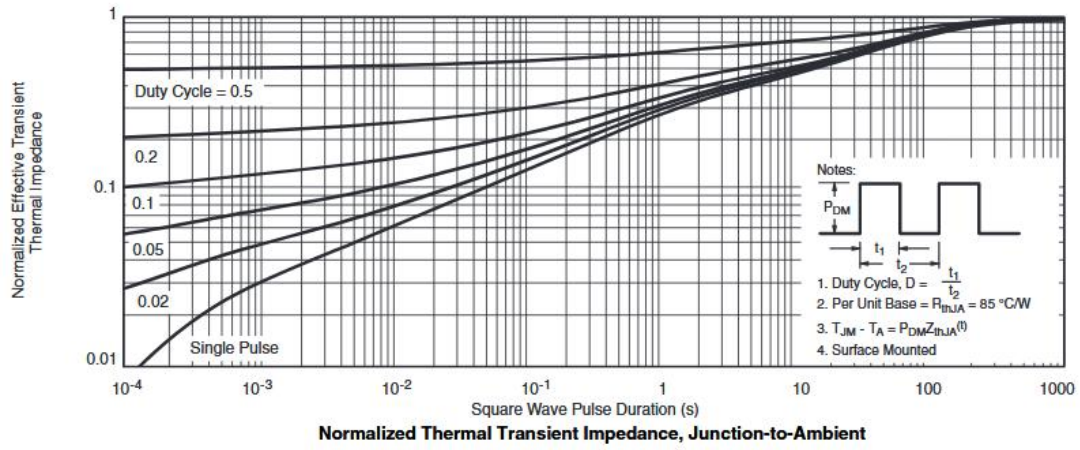



➤ Package Information

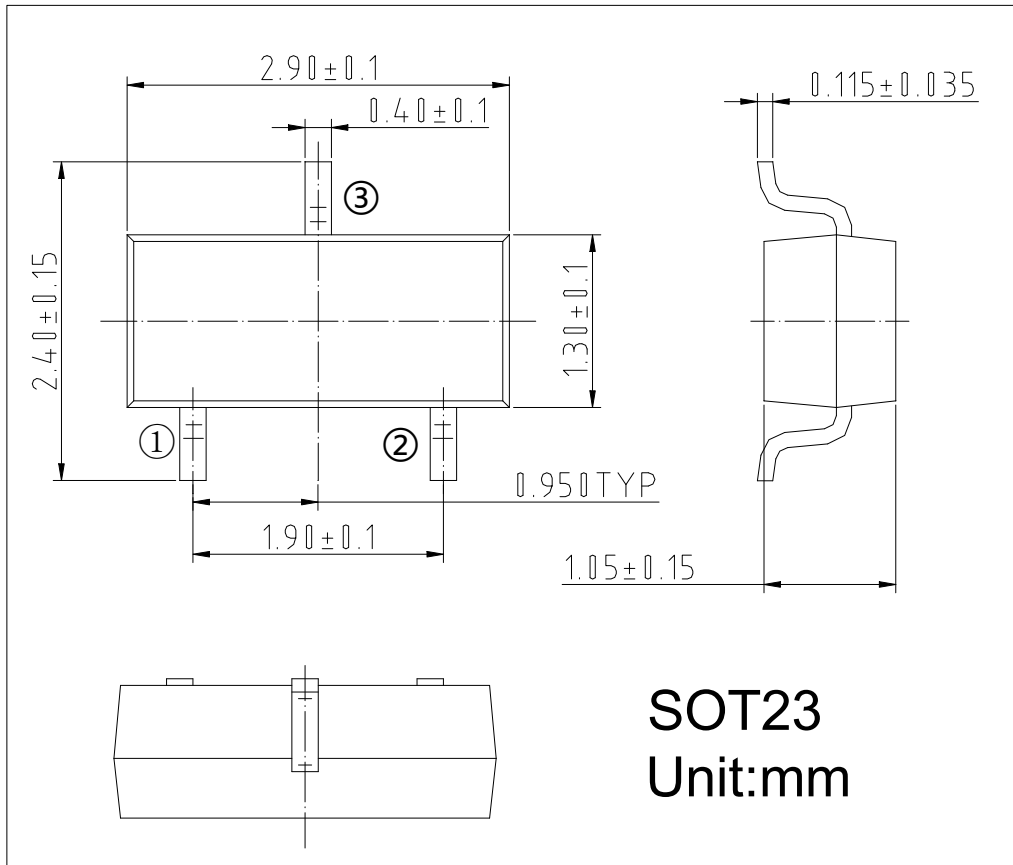



➤ **History Version**

V2.0	Product datasheet	2020-07-21
V2.1	Update $V_{GS(th)}$ Max limit value	2022-05-24

**DISCLAIMER**

AFSEMI RESERVES THE RIGHT TO MAKE CHANGES WITHOUT FURTHER NOTICE TO ANY PRODUCTS HEREIN TO IMPROVE RELIABILITY, FUNCTION OR DESIGN. AFSEMI DOES NOT ASSUME ANY LIABILITY ARISING OUT OF THE APPLICATION OR USE OF ANY PRODUCT OR CIRCUIT DESCRIBED HEREIN; NEITHER DOES IT CONVEY ANY LICENCE UNDER ITS PATENT RIGHTS, NOR THE RIGHTS OF OTHERS.

THE GRAPHS PROVIDED IN THIS DOCUMENT ARE STATISTICAL SUMMARIES BASED ON A LIMITED NUMBER OF SAMPLES AND ARE PROVIDED FOR INFORMATIONAL PURPOSE ONLY. THE PERFORMANCE CHARACTERISTICS LISTED IN THEM ARE NOT TESTED OR GUARANTEED. IN SOME GRAPHS, THE DATA PRESENTED MAY BE OUTSIDE THE SPECIFIED OPERATING RANGE (E.G. OUTSIDE SPECIFIED POWER SUPPLY RANGE) AND THEREFORE OUTSIDE THE WARRANTED RANGE.