



SSCE5V041SB

SSCE5V041SB

Ultra Low Capacitance Array for ESD Protection

● Description

The SSCE5V041SB is a high performance and low cost design which includes surge rated diode arrays to protect high speed data interfaces. The SSCE5V041SB family has been specifically designed to protected sensitive components. Which are connected to data and transmission lines, from over-voltage caused by Electrostatic Discharging(ESD). Electrical Fast Transients(EFT),and lightning.

The SSCE5V041SB is a unique design which includes surge rated, low capacitance steering diodes and a unique design of clamping cell which is an equivalent TVS diodes in a single package. During transient conditions, the steering diodes direct the transient to either the power supply line or to the ground line. The internal unique design of clamping cell prevents over-voltage on the power line, protecting any downstream components. The SSCE5V041SB may be used to meet the ESD immunity requirements of IEC 61000-4-2, level 4(±15KV air, ±10KV contact discharge).

● Feature

- ✧ SOT23-6L Package
- ✧ Provide ESD Protection for each channel to IEC 61000-4-2 (ESD) ±15KV(air), ±10KV(contact) IEC 61000-4-5(Lightning) (8/20us) 5A
- ✧ For low operating voltage applications:5V
- ✧ Low capacitance:0.6pF typical
- ✧ Fast turn-on and low clamping voltage
- ✧ Array of surge rated diodes with internal equivalent TVS diode
- ✧ Solid-state silicon-avalanche and active circuit triggering technology

● PIN configuration

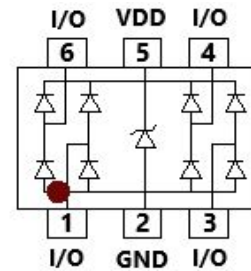

Top view

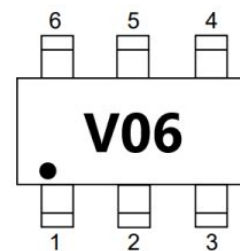

Marking

● Applications

- ✧ Video Graphics Cards
- ✧ USB2.0 Power and Data lines protection
- ✧ Notebook and PC Computers
- ✧ Monitors and Flat Panel Displays
- ✧ IEEE 1394 Firewire Ports
- ✧ SIM Ports

● Mechanical data

- ✧ Lead finish:100% matte Sn(Tin)
- ✧ Mounting position: Any
- ✧ Qualified max reflow temperature:260°C
- ✧ Device meets MSL 1 requirements
- ✧ Pure tin plating: 7 ~ 17 um
- ✧ Pin flatness:≤3mil



● Electronic Parameter

Symbol	Parameter
V_{RWM}	Peak Reverse Working Voltage
I_R	Reverse Leakage Current @ V_{RWM}
V_{BR}	Breakdown Voltage @ I_T
I_T	Test Current
I_{PP}	Maximum Reverse Peak Pulse Current
V_C	Clamping Voltage @ I_{PP}
P_{PP}	Peak Pulse Power
C	Junction Capacitance

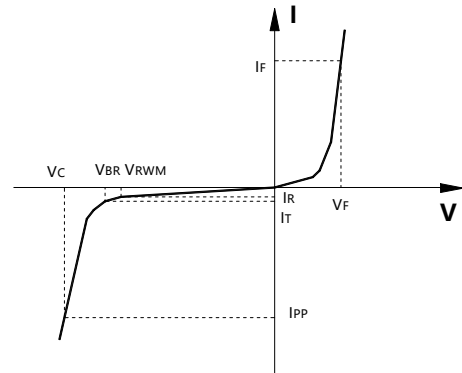

● Absolute maximum rating @TA=25°C

Symbol	Parameter	Value	Units
P_{PP}	Peak Pulse Power (8/20 μ s)	100	W
I_{PP}	Peak Pulse Current (8/20 μ s)	5	A
V_{ESD}	ESD per IEC 61000-4-2 (air)	15	KV
	ESD per IEC 61000-4-2 (contact)	10	
T_{SOL}	Lead Soldering Temperature	260 (10 sec.)	°C
T_{OP}	Operating Temperature	-55 to +125	°C
T_{STO}	Storage Temperature	-55 to +150	°C

● Electrical Characteristics @TA=25°C

Parameter	Symbol	Conditions	Min.	Typ.	Max.	Units
Reverse Working Voltage	V_{RWM}	Any I/O to Ground			5.0	V
Reverse Leakage Current	I_R	$V_{RWM}=5V$, Any I/O to Ground			1.0	μ A
Reverse Breakdown Voltage	V_{BR}	$I_T=1mA$, Any I/O to Ground	6.0			V
Forward Voltage	V_F	$I_F=15mA$		0.85	1.1	V
Clamping Voltage	V_{C1}	$I_{PP}=1A$, $t_P=8/20\mu s$, Any I/O to Ground		8.5	12	V
	V_{C2}	$I_{PP}=5A$, $t_P=8/20\mu s$, Any I/O to Ground		12	16	V
Junction Capacitance	C_J	$V_R = 0V$, $f = 1MHz$, between I/O pins		0.3	0.5	pF
		$V_R = 0V$, $f = 1MHz$, Any I/O pin to Ground		0.6	0.9	pF



● Typical Performance Characteristics

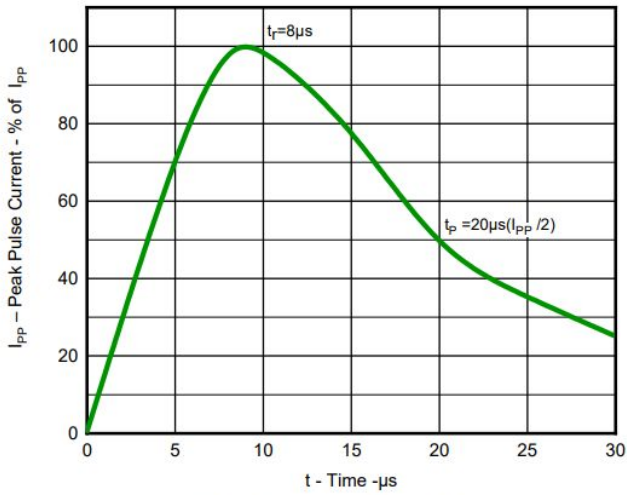

Fig 1. Pulse Waveform (8/20µs)

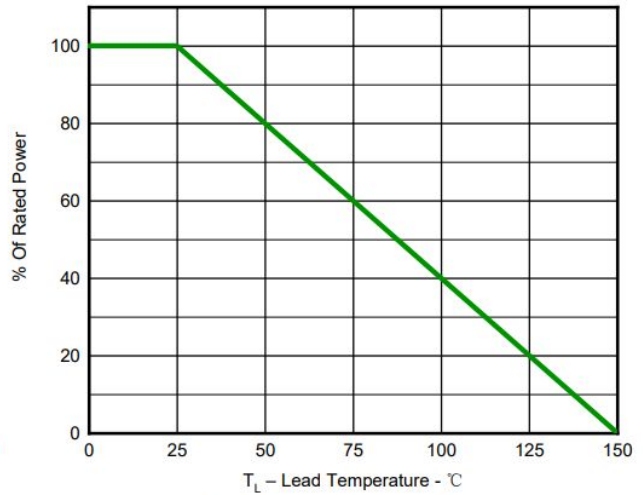

Fig 2. Power Derating Curve

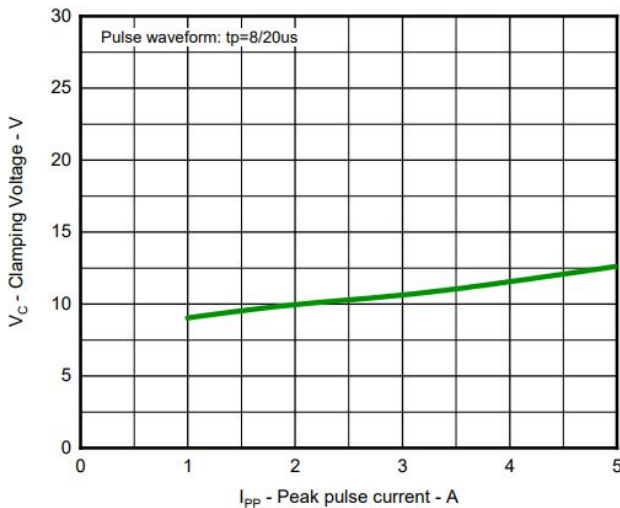

Fig 3. Clamping voltage vs. Peak pulse current

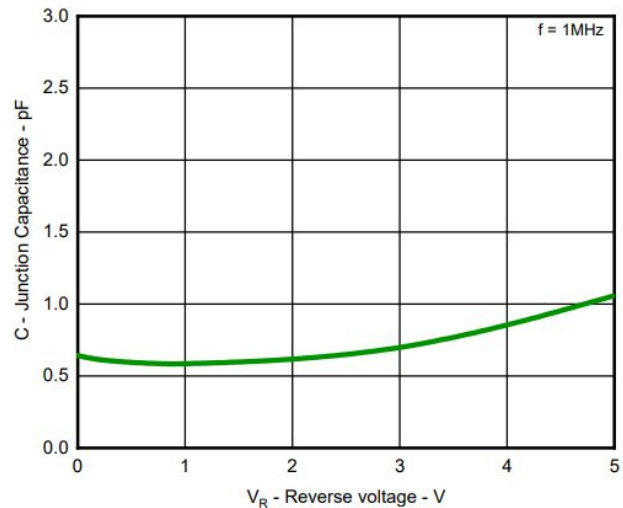

Fig 4. Capacitance vs. Reverse voltage



SSCE5V041SB

● Package Information

Ordering Information

Device	Package	Qty per Reel	Reel Size
SSCE5V041SB	SOT23-6L	3000	7 Inch

Mechanical Data

- Case: SOT23-6L
- Case Material: Molded Plastic. UL Flammability

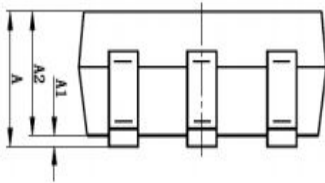
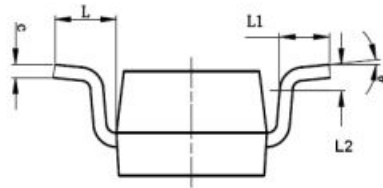
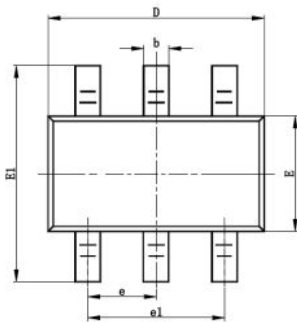

DIM	Millimeters	
	Min	Max
A	0.900	1.450
A1	0.000	0.150
A2	0.900	1.300
b	0.300	0.500
c	0.080	0.210
D	2.720	3.120
E	1.400	1.800
E1	2.600	2.950
e	0.950BSC	
e1	1.9BSC	
L1	0.300	0.600
L	0.7REF	
L2	0.25BSC	
θ	0	8

Recommended Pad outline

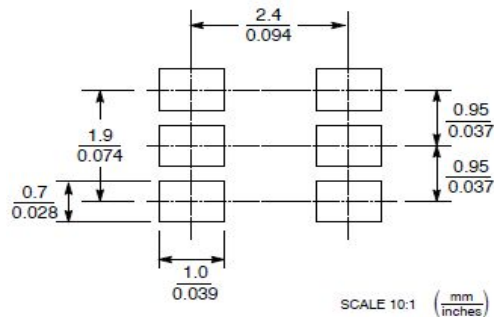



SSCE5V041SB

DISCLAIMER

AFSEMI RESERVES THE RIGHT TO MAKE CHANGES WITHOUT FURTHER NOTICE TO ANY PRODUCTS HEREIN TO IMPROVE RELIABILITY, FUNCTION OR DESIGN. AFSEMI DOES NOT ASSUME ANY LIABILITY ARISING OUT OF THE APPLICATION OR USE OF ANY PRODUCT OR CIRCUIT DESCRIBED HEREIN; NEITHER DOES IT CONVEY ANY LICENCE UNDER ITS PATENT RIGHTS, NOR THE RIGHTS OF OTHERS.

THE GRAPHS PROVIDED IN THIS DOCUMENT ARE STATISTICAL SUMMARIES BASED ON A LIMITED NUMBER OF SAMPLES AND ARE PROVIDED FOR INFORMATIONAL PURPOSE ONLY. THE PERFORMANCE CHARACTERISTICS LISTED IN THEM ARE NOT TESTED OR GUARANTEED. IN SOME GRAPHS, THE DATA PRESENTED MAY BE OUTSIDE THE SPECIFIED OPERATING RANGE (E.G., OUTSIDE SPECIFIED POWER SUPPLY RANGE) AND THEREFORE OUTSIDE THE WARRANTED RANGE.