



SSCT4V511D2

SSCT4V511D2

1-Line Uni-directional TVS Diode

● Description

The SSCT4V511D2 is an uni-directional TVS diode, utilizing leading monolithic silicon technology to provide fast response time and low ESD clamping voltage, making this device an ideal solution for protecting voltage sensitive data and power line. The SSCT4V511D2 complies with the IEC 61000-4-2 (ESD) with $\pm 30\text{kV}$ air and $\pm 30\text{kV}$ contact discharge. The small size and high ESD surge protection make SSCT4V511D2 an ideal choice to protect cell phone, digital cameras, audio players and many other portable applications.

● Features

- ◇ 2550W Peak Pulse Power per Line ($t_p=8/20 \mu\text{s}$)
- ◇ Protects one data or power line
- ◇ Working voltage:4.5V
- ◇ 2-pin leadless package
- ◇ Complies with following standards:
 - IEC61000-4-2(ESD) $\pm 30\text{Kv}$ (contact), $\pm 30\text{kV}$ (air)
 - IEC61000-4-4(EFT) 40A(5/50ns)
 - IEC61000-4-5(Lightning) 170A(8/20 μs)
- ◇ RoHS Compliant

● PIN configuration

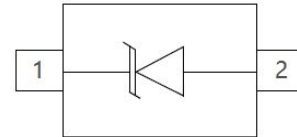

Top view



Marking

● Applications

- ◇ Mobile Phones
- ◇ Battery Protection
- ◇ Power Line Protection
- ◇ Vbat pin for Mobile Devices
- ◇ Hand Held Portable Applications

● Mechanical Characteristics

- ◇ Package:SOD-323
- ◇ Case Material: "Green" Molding Compound.
- ◇ UL Flammability Classification Rating 94V-0
- ◇ Moisture Sensitivity: Level 3 per J-STD-020
- ◇ Terminal Connections: See Diagram Below
- ◇ Marking Information: See Below



SSCT4V511D2

● Electronic Parameter

Symbol	Parameter
V_{RWM}	Peak Reverse Working Voltage
I_R	Reverse Leakage Current @ V_{RWM}
V_{BR}	Breakdown Voltage @ I_T
I_T	Test Current
I_{PP}	Maximum Reverse Peak Pulse Current
V_C	Clamping Voltage @ I_{PP}
P_{PPP}	Peak Pulse Power
C	Junction Capacitance

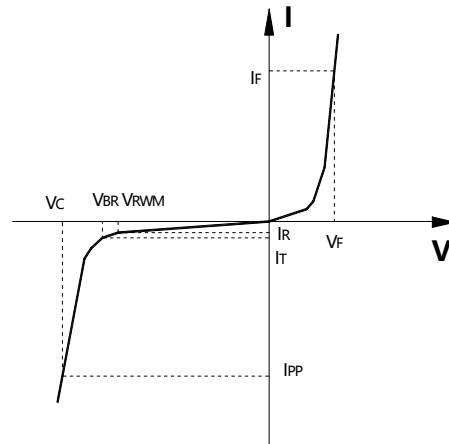

● Absolute maximum rating @ $T_A=25^\circ\text{C}$

Symbol	Parameter	Value	Units
V_{ESD}	ESD Rating per IEC61000-4-2:Contact Air	± 30 ± 30	KV
P_{PPP}	Peak Pulse Power (8/20 μs)	2550	W
I_{PP}	Peak Pulse Current (8/20 μs)	170	A
T_{STG}	Storage Temperature	-55/+150	$^\circ\text{C}$
T_J	Operating Temperature	-55/+125	$^\circ\text{C}$

● Electrical Characteristics @ $T_A=25^\circ\text{C}$

Parameter	Symbol	Conditions	Min.	Typ.	Max.	Units
Peak Reverse Working Voltage	V_{RWM}	Any I/O to Ground		4.5		V
Breakdown Voltage	V_{BR}	$I_T = 1\text{mA}$	4.8			V
Reverse Leakage Current	I_R	$V_{RWM} = 4.5\text{V}$			0.2	μA
Forward Voltage	V_F	$I_F = 10\text{mA}$	0.6		1.0	V
Clamping Voltage	V_{C1}	$I_{PP} = 1\text{A}$, $t_P = 8/20\mu\text{s}$			8.5	V
Clamping Voltage	V_{C2}	$I_{PP} = 170\text{A}$, $t_P = 8/20\mu\text{s}$			15	V
Dynamic Resistance ^{1,2}	R_{DYN}	$TLP = 0.2/100\text{ns}$		0.05		Ω
Junction Capacitance	C_J	$V_R = 0\text{V}$, $f = 1\text{MHz}$,		450	600	pF

Note: 1、TLP Setting: $t_p = 100\text{ns}$, $t_r = 0.2\text{ns}$, I_{TLP} and V_{TLP} sample window: $t_1 = 70\text{ns}$ to $t_2 = 90\text{ns}$.

2、Dynamic resistance calculated from $I_{PP} = 4\text{A}$ to $I_{PP} = 16\text{A}$ using “Best Fit”



SSCT4V511D2

● **Typical Performance Characteristics**($T_A=25^\circ\text{C}$ unless otherwise Specified)

Figure 1: Peak Pulse Power vs. Pulse Time

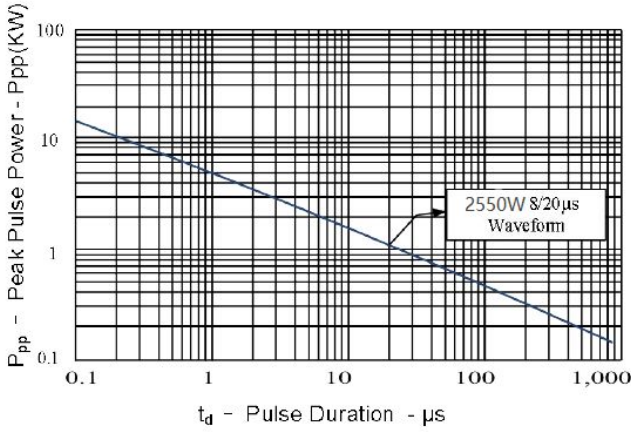

Figure 2: Power Derating Curve

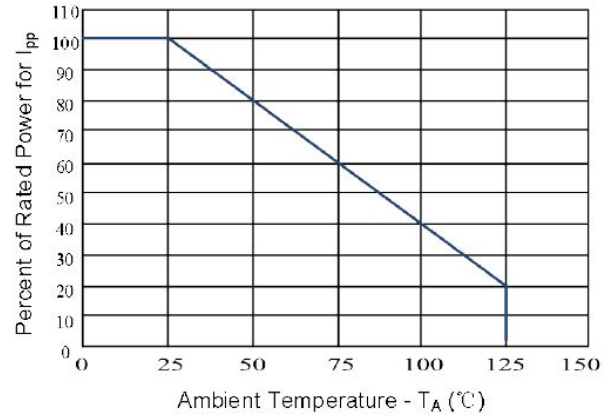

Figure 3: Clamping Voltage vs. Peak Pulse Current

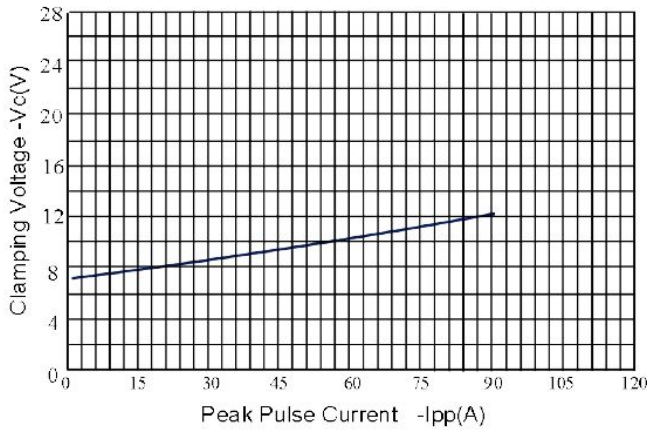

Figure 4: Normalized Junction Capacitance vs. Reverse Voltage

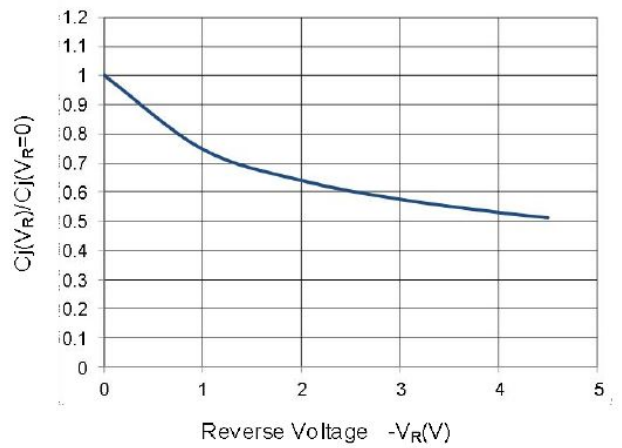

Figure 5: 8/20μs Pulse Waveform

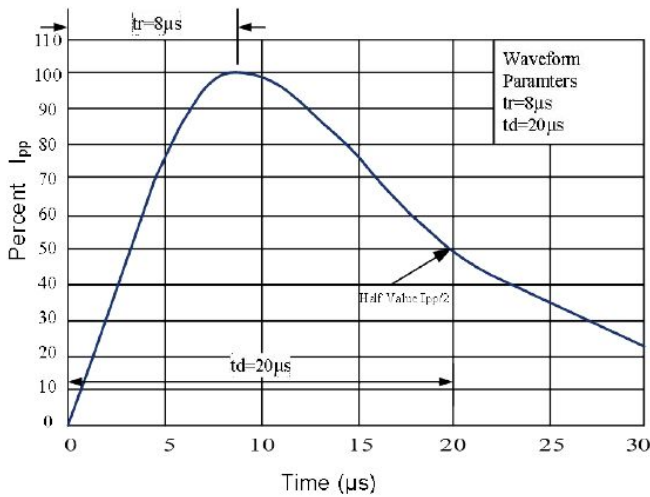
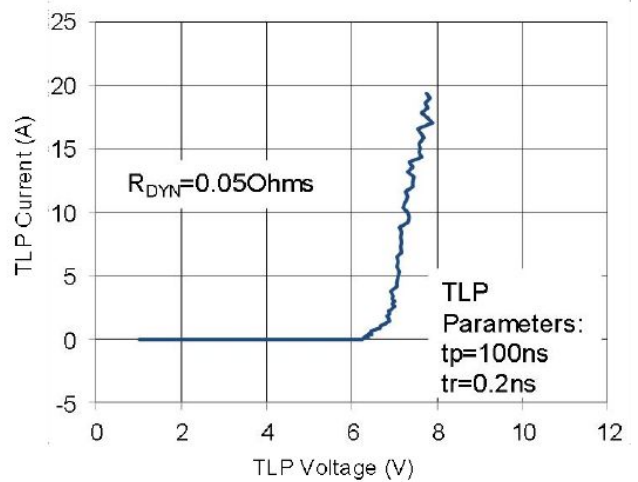

Figure 6: TLP Curve





- Soldering Parameters**

Reflow Condition		Pb-Free assembly (see as bellow)
Pre Heat	-Temperature Min (Ts(min))	+150°C
	-Temperature Max(Ts(max))	+200°C
	-Time (Min to Max) (ts)	60-180 secs.
Average ramp up rate (Liquid us Temp (TL) to peak)		3°C/sec. Max
Ts(max) to TL - Ramp-up Rate		3°C/sec. Max
Reflow	-Temperature(TL)(Liquid us)	+217°C
	-Temperature(TL)	60-150 secs.
Peak Temp (Tp)		+260(+0/-5)°C
Time within 5°C of actual Peak Temp (tp)		30 secs. Max
Ramp-down Rate		6°C/sec. Max
Time 25°C to Peak Temp (TP)		8 min. Max
Do not exceed		+260°C

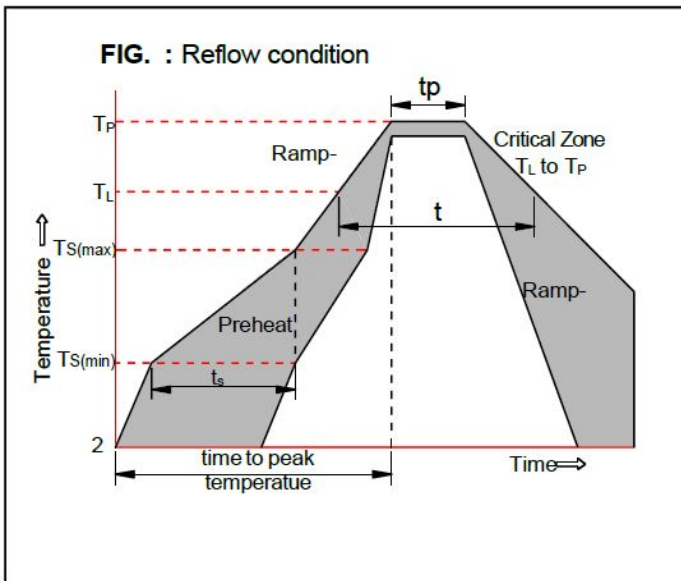



SSCT4V511D2

- **Package Information**

Ordering Information

Device	Package	Qty per Reel	Reel Size
SSCT4V511D2	SOD-323	3000	7 Inch

Mechanical Data

Case: SOD-323

Case Material: Molded Plastic. UL Flammability

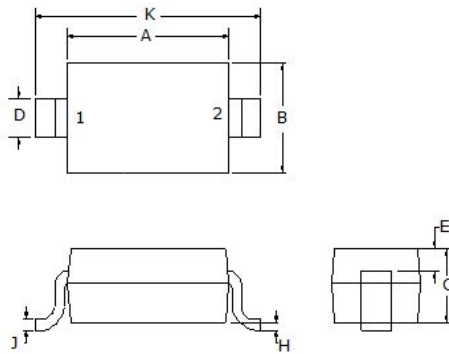

Dim	Dimensions			
	Millimeters		Inches	
	Min	Max	Min	Max
A	1.50	1.80	0.060	0.071
B	1.2	1.40	0.045	0.054
C	-	1.10	-	0.043
D	0.30	0.40	0.012	0.016
H	-	0.10	-	0.004
J	0.10	0.25	0.004	0.010
K	2.30	2.70	0.090	0.107

Suggested Land Pattern

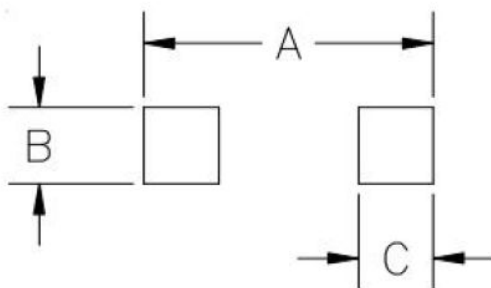

Dim	Dimensions	
	Millimeters	Inches
A	3.15	0.120
B	0.80	0.031
C	0.80	0.031



SSCT4V511D2

DISCLAIMER

AFSEMI RESERVES THE RIGHT TO MAKE CHANGES WITHOUT FURTHER NOTICE TO ANY PRODUCTS HEREIN TO IMPROVE RELIABILITY, FUNCTION OR DESIGN. AF SEMI DOES NOT ASSUME ANY LIABILITY ARISING OUT OF THE APPLICATION OR USE OF ANY PRODUCT OR CIRCUIT DESCRIBED HEREIN; NEITHER DOES IT CONVEY ANY LICIENCE UNDER ITS PATENT RIGHTS, NOR THE RIGHTS OF OTHERS.

THE GRAPHS PROVIDED IN THIS DOCUMENT ARE STATISTICAL SUMMARIES BASED ON A LIMITED NUMBER OF SAMPLES AND ARE PROVIDED FOR INFORMATIONAL PURPOSE ONLY. THE PERFORMANCE CHARACTERISTICS LISTED IN THEM ARE NOT TESTED OR GUARANTEED. IN SOME GRAPHS, THE DATA PRESENTED MAY BE OUTSIDE THE SPECIFIED OPERATING RANGE (E.G., OUTSIDE SPECIFIED POWER SUPPLY RANGE) AND THEREFORE OUTSIDE THE WARRANTED RANGE.