



SSCT5V011L3

SSCT5V011L3

1-Line Uni-directional TVS Diode

● Description

The SSCT5V011L3 is an uni-directional TVS diode, utilizing leading monolithic silicon technology to provide fast response time and low ESD clamping voltage, making this device an ideal solution for protecting voltage sensitive data and power line. The SSCT5V011L3 complies with the IEC 61000-4-2 (ESD) with $\pm 30\text{kV}$ air and $\pm 30\text{kV}$ contact discharge. It is assembled into an ultra-small 1.6x1.0x0.5mm lead-free DFN package. The small size and high ESD surge protection make SSCT5V011L3 an ideal choice to protect cell phone, digital cameras, audio players and many other portable applications.

● Features

- ◇ Ultra small package:1.6x1.0x0.5mm
- ◇ Protects one data or power line
- ◇ Working voltage:5V
- ◇ 2-pin leadless package
- ◇ Complies with following standards:
 - IEC61000-4-2(ESD) $\pm 30\text{Kv}$ (contact), $\pm 30\text{kV}$ (air)
 - IEC61000-4-5(Lightning) 120A(8/20 μs)
- ◇ RoHS Compliant

● PIN configuration



Top view



Marking

● Applications

- ◇ Mobile Phones
- ◇ Battery Protection
- ◇ Power Line Protection
- ◇ Vbat pin for Mobile Devices
- ◇ Hand Held Portable Applications

● Mechanical Characteristics

- ◇ Package:DFN1610-2L(1.6x1.0x0.5mm)
- ◇ Case Material: “Green” Molding Compound.
- ◇ UL Flammability Classification Rating 94V-0
- ◇ Moisture Sensitivity: Level 3 per J-STD-020
- ◇ Terminal Connections: See Diagram Below
- ◇ Marking Information: See Below



SSCT5V011L3

● Electronic Parameter

Symbol	Parameter
V_{RWM}	Peak Reverse Working Voltage
I_R	Reverse Leakage Current @ V_{RWM}
V_{BR}	Breakdown Voltage @ I_T
I_T	Test Current
I_{PP}	Maximum Reverse Peak Pulse Current
V_C	Clamping Voltage @ I_{PP}
P_{PPP}	Peak Pulse Power
C	Junction Capacitance

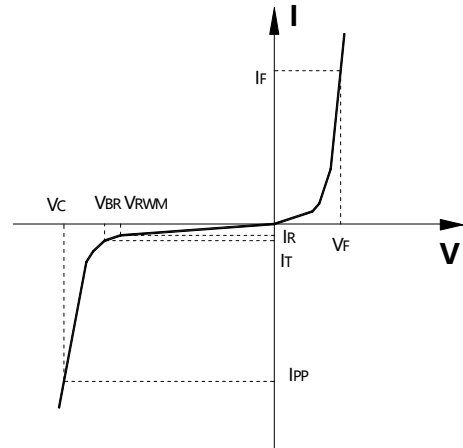

● Absolute maximum rating @ $T_A=25^{\circ}C$

Symbol	Parameter	Value	Units
VESD	ESD Rating per IEC61000-4-2:Contact	± 30	KV
	Air	± 30	
P_{PPP}	Peak Pulse Power (8/20 μ s)	1800	W
I_{PP}	Peak Pulse Current (8/20 μ s)	120	A
T_{STG}	Storage Temperature	-55/+150	$^{\circ}C$
T_J	Operating Temperature	-55/+125	$^{\circ}C$

● Electrical Characteristics @ $T_A=25^{\circ}C$

Parameter	Symbol	Conditions	Min.	Typ.	Max.	Units
Peak Reverse Working Voltage	V_{RWM}	Any I/O to Ground			6	V
Breakdown Voltage	V_{BR}	$I_T = 1mA$	6			V
Reverse Leakage Current	I_R	$V_{RWM} = 5V, T = 25^{\circ}C$			1.0	μA
Forward Voltage	V_F	$I_F = 10mA$		1.0	1.2	V
Clamping Voltage	V_{C1}	$I_{PP} = 10A, t_P = 8/20\mu s$			8.5	V
Clamping Voltage	V_{C2}	$I_{PP} = 120A, t_P = 8/20\mu s$			15	V
Junction Capacitance	C_J	$V_R = 0V, f = 1MHz,$			750	pF



SSCT5V011L3

● Typical Performance Characteristics(T_A=25°C unless otherwise Specified)

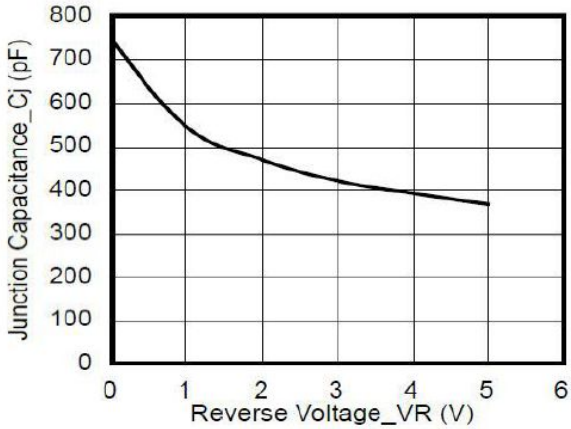

Junction Capacitance vs. Reverse Voltage

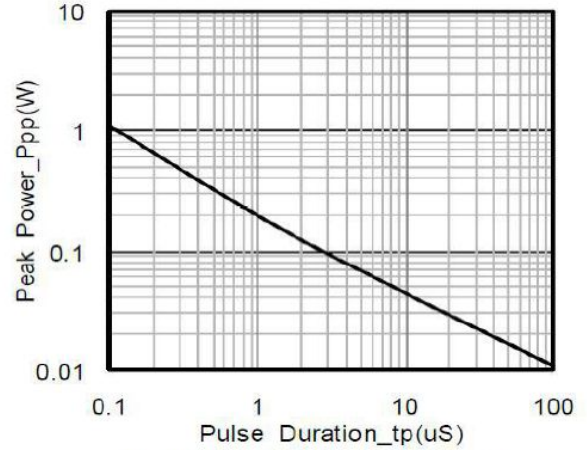

Peak Pulse Power vs. Pulse Time

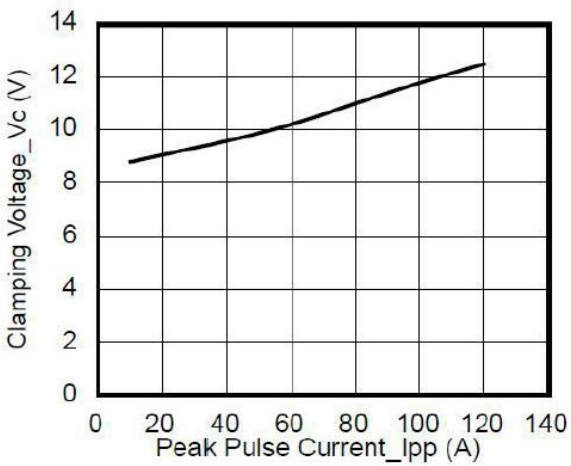

Clamping Voltage vs. Peak Pulse Current

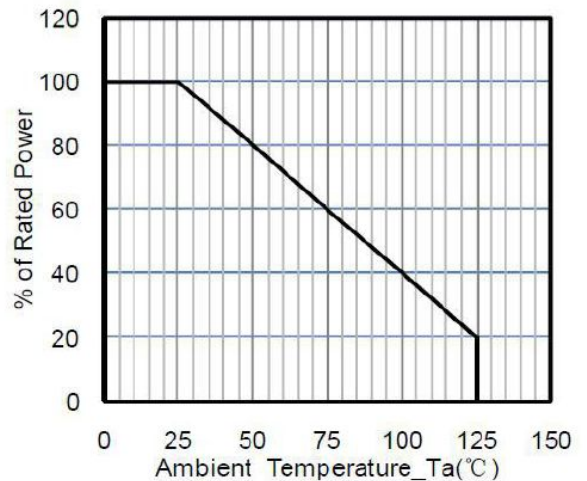

Power Derating Curve

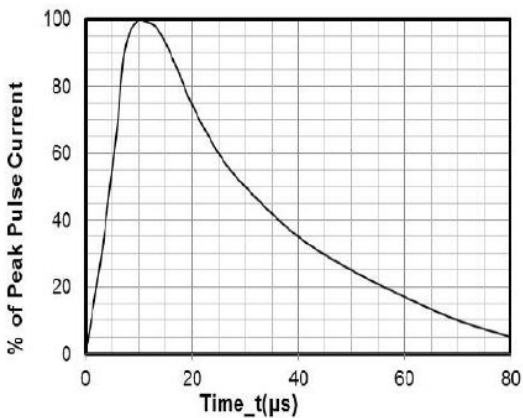

8 X 20μs Pulse Waveform

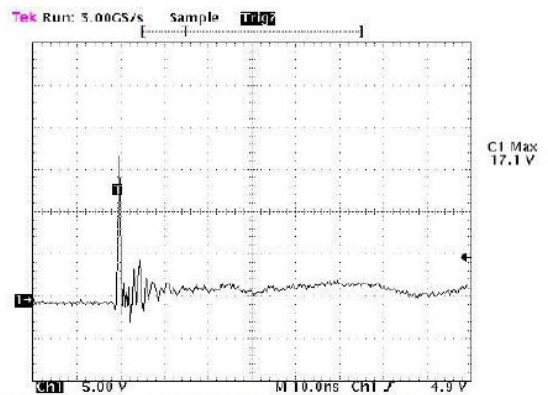

Note: Data is taken with a 10x attenuator

ESD Clamping Voltage

+8 kV Contact per IEC61000-4-2



- Soldering Parameters**

Reflow Condition		Pb-Free assembly (see as bellow)
Pre Heat	-Temperature Min (Ts(min))	+150°C
	-Temperature Max(Ts(max))	+200°C
	-Time (Min to Max) (ts)	60-180 secs.
Average ramp up rate (Liquid us Temp (TL) to peak)		3°C/sec. Max
Ts(max) to TL - Ramp-up Rate		3°C/sec. Max
Reflow	-Temperature(TL)(Liquid us)	+217°C
	-Temperature(TL)	60-150 secs.
Peak Temp (Tp)		+260(+0/-5)°C
Time within 5°C of actual Peak Temp (tp)		30 secs. Max
Ramp-down Rate		6°C/sec. Max
Time 25°C to Peak Temp (TP)		8 min. Max
Do not exceed		+260°C

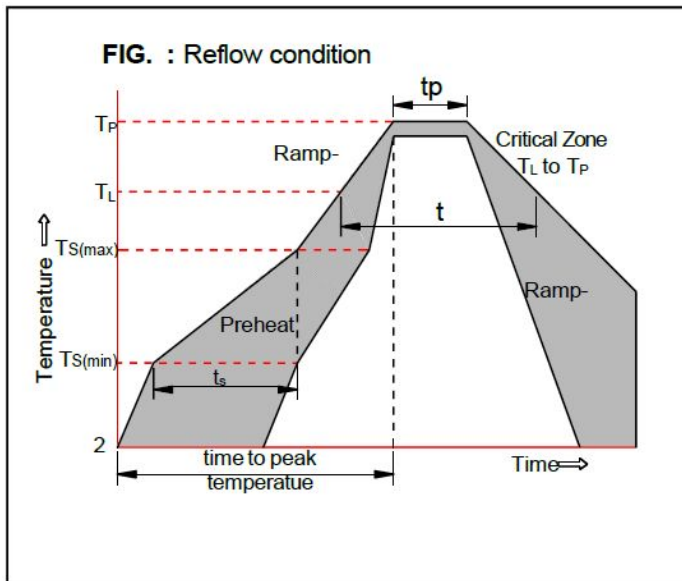



SSCT5V011L3

● Package Information

Ordering Information

Device	Package	Qty per Reel	Reel Size
SSCT5V011L3	DFN1610-2L	3000	7 Inch

Mechanical Data

Case: DFN1610-2L

Case Material: Molded Plastic. UL Flammability

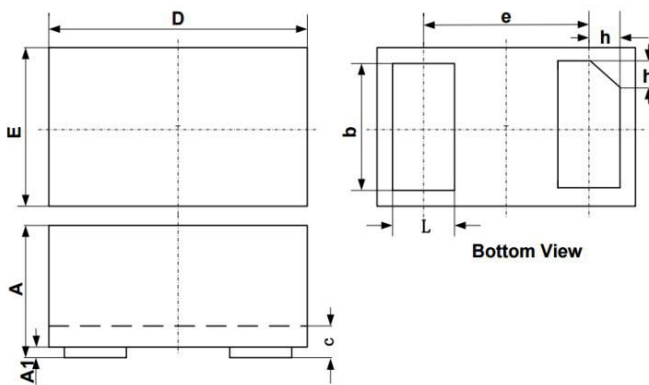

SYM	DIMENSIONS					
	MILLIMETERS			INCHES		
	MIN	NOM	MAX	MIN	NOM	MAX
A	0.45	0.50	0.55	0.018	0.020	0.022
A1	0.00	0.02	0.05	0.000	0.001	0.002
b	0.75	0.80	0.85	0.030	0.032	0.034
c	0.10	0.15	0.20	0.004	0.006	0.007
D	1.55	1.60	1.65	0.062	0.064	0.066
e	1.10 BSC			0.044 BSC		
E	0.95	1.00	1.05	0.038	0.040	0.042
L	0.35	0.40	0.45	0.014	0.016	0.018
h	0.15	0.20	0.25	0.006	0.008	0.010

Suggested Land Pattern

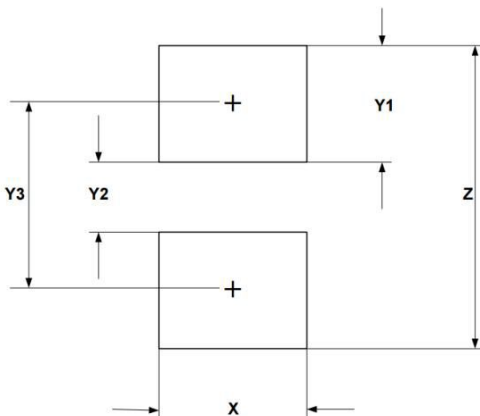

SYM	DIMENSIONS	
	MILLIMETERS	INCHES
X	1.00	0.040
Y1	0.62	0.025
Y2	0.60	0.024
Y3	1.22	0.049
Z	1.85	0.074



SSCT5V011L3

DISCLAIMER

AFSEMI RESERVES THE RIGHT TO MAKE CHANGES WITHOUT FURTHER NOTICE TO ANY PRODUCTS HEREIN TO IMPROVE RELIABILITY, FUNCTION OR DESIGN. AF SEMI DOES NOT ASSUME ANY LIABILITY ARISING OUT OF THE APPLICATION OR USE OF ANY PRODUCT OR CIRCUIT DESCRIBED HEREIN; NEITHER DOES IT CONVEY ANY LICENCE UNDER ITS PATENT RIGHTS, NOR THE RIGHTS OF OTHERS.

THE GRAPHS PROVIDED IN THIS DOCUMENT ARE STATISTICAL SUMMARIES BASED ON A LIMITED NUMBER OF SAMPLES AND ARE PROVIDED FOR INFORMATIONAL PURPOSE ONLY. THE PERFORMANCE CHARACTERISTICS LISTED IN THEM ARE NOT TESTED OR GUARANTEED. IN SOME GRAPHS, THE DATA PRESENTED MAY BE OUTSIDE THE SPECIFIED OPERATING RANGE (E.G., OUTSIDE SPECIFIED POWER SUPPLY RANGE) AND THEREFORE OUTSIDE THE WARRANTED RANGE.