



SSC8048GQ4

N-Channel Enhanced MOSFET

➤ Features

VDS	VGS	RDS(on) Typ.	ID
40V	±20V	7.2mR@10V	38A
		9mR@4V5	

➤ Description

This device is N-Channel enhancement MOSFET. Uses advanced trench technology and design to provide excellent RDS(on) with low gate charge. This device is suitable for use in DC-DC conversion, power switch and charging circuit.

➤ Applications

- DC/DC converters
- Power supplies
- Motor Drive Control
- Synchronous rectification

➤ Ordering Information

Device	Package	Shipping
SSC8048GQ4	DFN3X3	5000/Reel

➤ Pin configuration

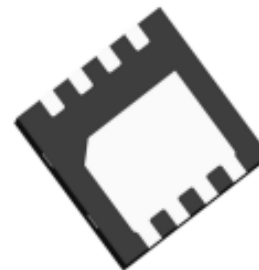
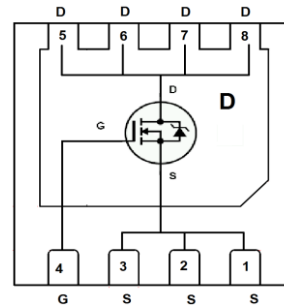

Bottom View

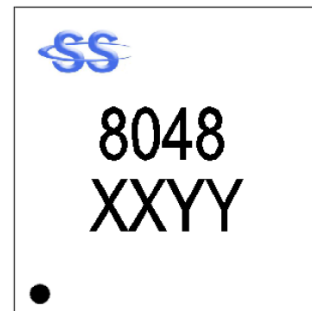

Marking

(XX: product year / YY: product week)



➤ **Absolute Maximum Ratings**($T_A=25^{\circ}\text{C}$ unless otherwise noted)

Symbol	Parameter	Ratings	Unit	
V_{DSS}	Drain-to-Source Voltage	40	V	
V_{GSS}	Gate-to-Source Voltage	± 20	V	
I_D	Continuous Drain Current ^d	$T_C=25^{\circ}\text{C}$	38	A
		$T_C=100^{\circ}\text{C}$	30	
I_{DSM}	Continuous Drain Current ^a	$T_A=25^{\circ}\text{C}$	21	A
		$T_A=70^{\circ}\text{C}$	14	
I_{DM}	Pulsed Drain Current ^b	100	A	
P_D	Power Dissipation ^c	$T_C=25^{\circ}\text{C}$	25.5	W
		$T_C=100^{\circ}\text{C}$	10.6	
P_{DSM}	Power Dissipation ^a	$T_A=25^{\circ}\text{C}$	3.2	W
		$T_A=70^{\circ}\text{C}$	2	
I_{AS}	Avalanche Current ^b L=0.5mH Single Pulse	22	A	
E_{AS}	Avalanche Energy ^b L=0.5mH Single Pulse	121	mJ	
T_J	Operation junction temperature	-55~150	$^{\circ}\text{C}$	
T_{STG}	Storage temperature range	-55~150		

➤ **Thermal Resistance Ratings**($T_A=25^{\circ}\text{C}$ unless otherwise noted)

Symbol	Parameter	Ratings	Unit
$R_{\theta JA}$	Junction-to-Ambient Thermal Resistance ^a	39	$^{\circ}\text{C}/\text{W}$
$R_{\theta JC}$	Junction-to-Case Thermal Resistance	4.9	

Note:

- The value of $R_{\theta JA}$ is measured with the device mounted on 1 in² FR-4 board with 2oz.copper, in a still air environment with $T_A=25^{\circ}\text{C}$. The value in any given application depends on the user is specific board design. The power dissipation is based on the $t \leq 10\text{s}$ thermal resistance rating.
- Repetitive rating, pulse width limited by junction temperature.
- The power dissipation P_D is based on $T_{J(\text{MAX})}=150^{\circ}\text{C}$, using junction-to-case thermal resistance, and is more useful in setting the upper dissipation limit for cases where additional heat sinking is used.
- The maximum current rating is package limited.



➤ **Electronics Characteristics**($T_A=25^{\circ}\text{C}$ unless otherwise noted)

Symbol	Parameter	Test Conditions	Min	Typ.	Max	Unit
$V_{(BR)DSS}$	Drain-Source Breakdown Voltage	$V_{GS}=0V, I_D=250\mu A$	40			V
$V_{GS(th)}$	Gate Threshold Voltage	$V_{DS}=V_{GS}, I_D=250\mu A$	1	1.8	2.5	V
$R_{DS(on)}$	Drain-Source On-Resistance	$V_{GS}=10V, I_D=20A$		7.2	9.6	mR
		$V_{GS}=4.5V, I_D=10A$		9	13	
I_{DSS}	Zero Gate Voltage Drain Current	$V_{DS}=32V, V_{GS}=0V$			1	μA
I_{GSS}	Gate-Source leak current	$V_{GS}=\pm 20V, V_{DS}=0V$			± 100	nA
G_{FS}	Transconductance	$V_{DS}=5V, I_D=20A$		32		S
V_{SD}	Forward Voltage	$V_{GS}=0V, I_S=10A$		0.8	1.3	V
R_g	Gate Resistance	$V_{DS}=0V, f=1MHz$		1.1		R
C_{iss}	Input Capacitance	$V_{DS}=20V, V_{GS}=0V, f=1MHz$		3000		pF
C_{oss}	Output Capacitance			150		
C_{rss}	Reverse Transfer Capacitance			50		
$T_{D(ON)}$	Turn-on delay time	$V_{GS}=10V, R_L=10R$ $V_{DS}=20V, R_G=6R$		12		ns
T_r	Rise time			11		
$T_{D(OFF)}$	Turn-off delay time			32		
T_f	Fall time			12		
Q_G	Total Gate Charge	$V_{GS}=10V, V_{DS}=20V$ $I_D=20A$		41		nC
Q_{GS}	Gate Source Charge			6		
Q_{GD}	Gate Drain Charge			6.5		
T_{rr}	Diode Recovery Time	$I_F=10A, di/dt=100A/\mu s$		33		ns
Q_{rr}	Diode Recovery Charge	$I_F=10A, di/dt=100A/\mu s$		25		nC



➤ **Typical Characteristics** ($T_A=25^\circ\text{C}$ unless otherwise noted)

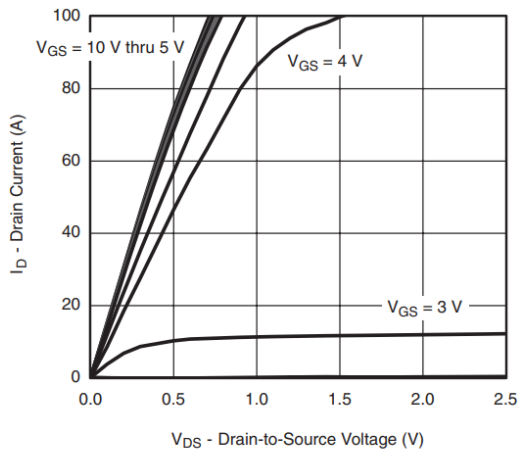

Output Characteristics

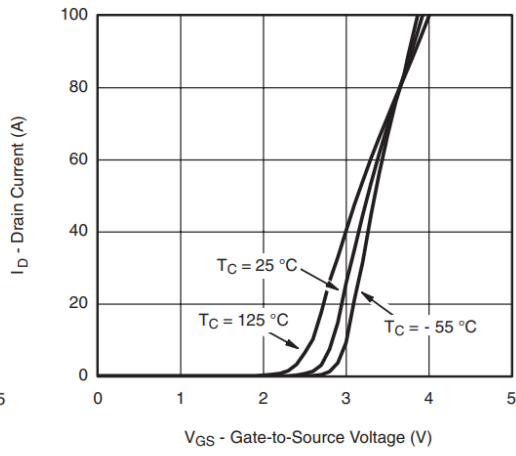

Transfer Characteristics

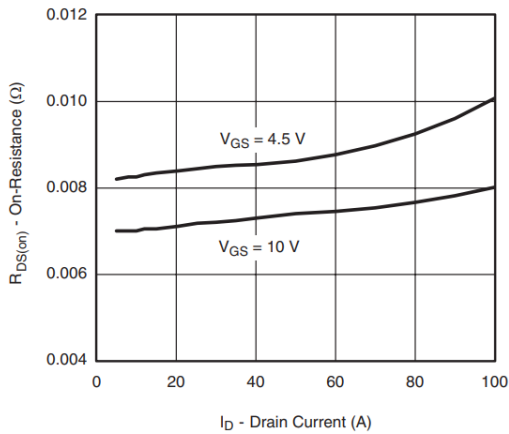

On-Resistance vs. Drain Current

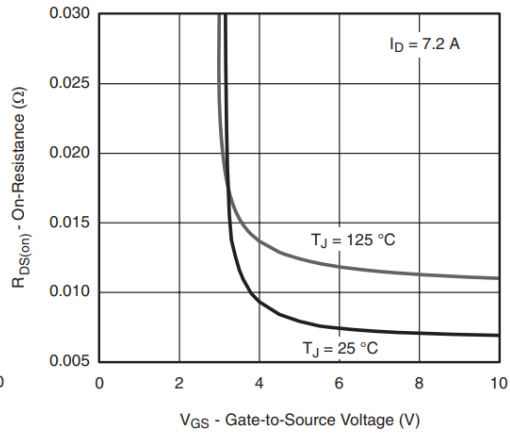

On-Resistance vs. Gate-to-Source Voltage

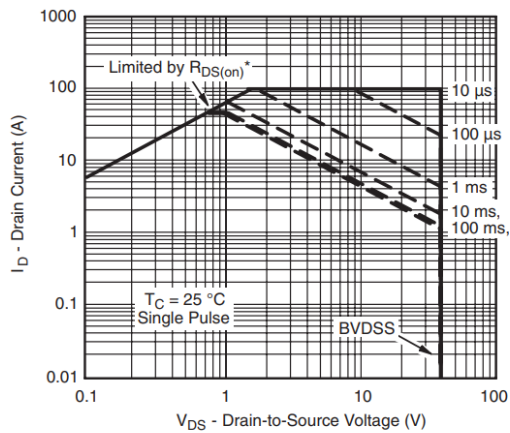

Safe Operating Area, Junction-to-Case
* V_{GS} > minimum V_{GS} at which $R_{DS(on)}$ is specified

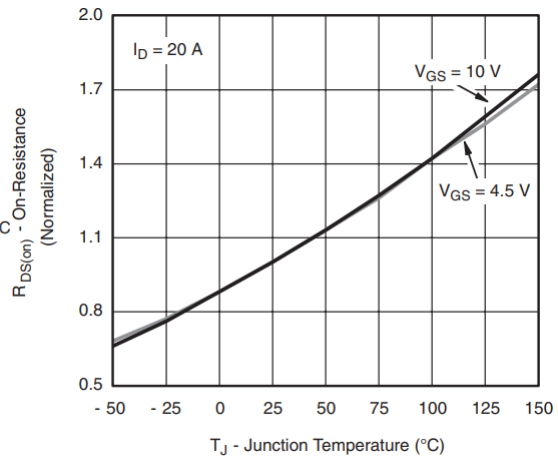

On-Resistance vs. Junction Temperature



➤ Package Information

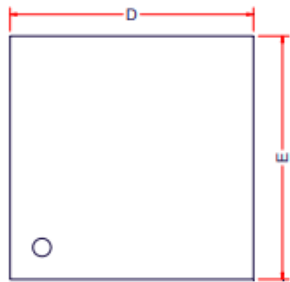

TOP VIEW

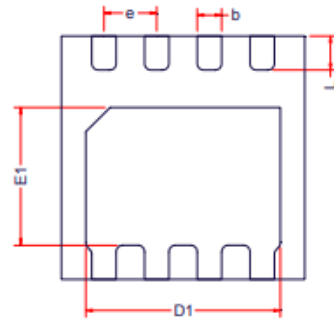

BOTTOM VIEW

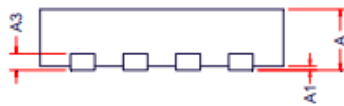

SIDE VIEW

Package: DNF3X3-8L

Symbol	Dimensions in Millimeters		
	Min.	Typ.	Max.
A	0.70	0.75	0.80
A1	0.00	0.02	0.05
A2	0.20Ref		
D	2.90	3.00	3.10
E	2.90	3.00	3.10
D1	2.35	2.40	2.45
E1	1.65	1.70	1.75
b	0.25	0.30	0.35
e	0.65BSC		
L	0.37	0.42	0.47



➤ Tape and Reel

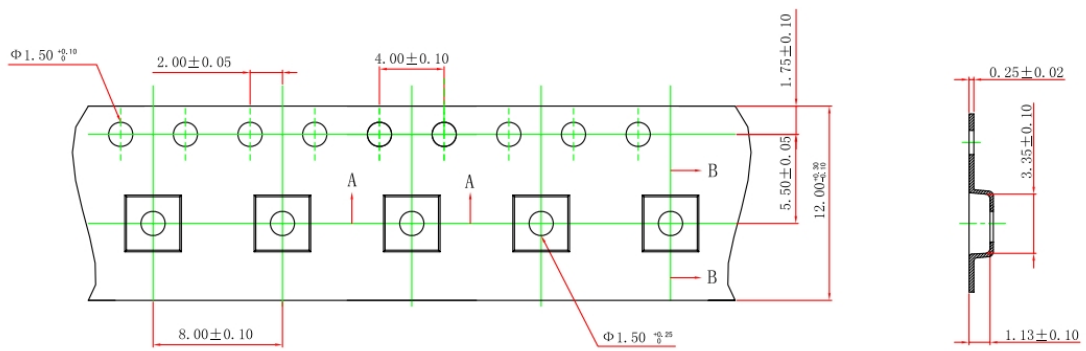
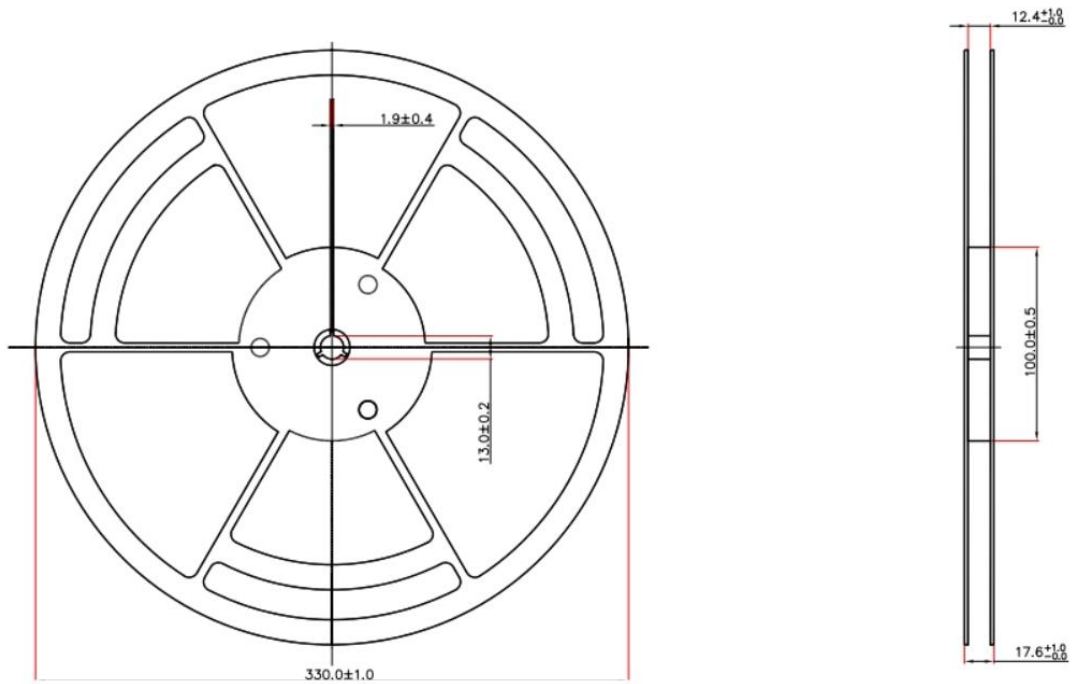

SECTION B-B

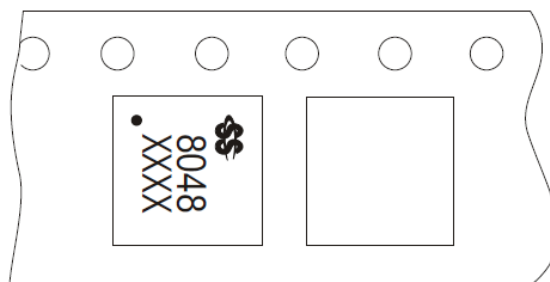



DISCLAIMER

AFSEMI RESERVES THE RIGHT TO MAKE CHANGES WITHOUT FURTHER NOTICE TO ANY PRODUCTS HEREIN TO IMPROVE RELIABILITY, FUNCTION OR DESIGN. AFSEMI DOES NOT ASSUME ANY LIABILITY ARISING OUT OF THE APPLICATION OR USE OF ANY PRODUCT OR CIRCUIT DESCRIBED HEREIN; NEITHER DOES IT CONVEY ANY LICENCE UNDER ITS PATENT RIGHTS, NOR THE RIGHTS OF OTHERS.

THE GRAPHS PROVIDED IN THIS DOCUMENT ARE STATISTICAL SUMMARIES BASED ON A LIMITED NUMBER OF SAMPLES AND ARE PROVIDED FOR INFORMATIONAL PURPOSE ONLY. THE PERFORMANCE CHARACTERISTICS LISTED IN THEM ARE NOT TESTED OR GUARANTEED. IN SOME GRAPHS, THE DATA PRESENTED MAY BE OUTSIDE THE SPECIFIED OPERATING RANGE (E.G. OUTSIDE SPECIFIED POWER SUPPLY RANGE) AND THEREFORE OUTSIDE THE WARRANTED RANGE.