



## SSCT24V11L2

High Power TVS Diode

### ● Description

The SSCT24V11L2 is a high power TVS, utilizing leading monolithic silicon technology to provide fast response time and low ESD clamping voltage, making this device an ideal solution for protecting voltage sensitive lines. The SSCT12V11L2 complies with the IEC 610002 (ESD) standard with  $\pm 30\text{kV}$  air and  $\pm 30\text{kV}$  contact discharge. It is assembled into a 3pin DFN20203 package. The leads are finished with NiPdAu. Each device will protect one line. The combination of small size, and high surge capability makes them ideal for use in applications such as cellular phones, LCD displays, USB, and multimedia card interfaces.

### ● Feature

- ✧ 5500W peak pulse power (TP = 8/20 $\mu\text{s}$ )
- ✧ DFN2020-3Package
- ✧ Working voltage: 12V
- ✧ Low clamping voltage
- ✧ Low capacitance
- ✧ RoHS compliant transient protection for high speed data lines to IEC61000-4-2(ESD) $\pm 30\text{kV}$ (air), $\pm 30\text{kV}$ (contact)

### ● PIN configuration

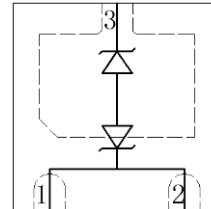

Topview

### ● Applications

- ✧ DVI & HDMI Port Protection
- ✧ Serial and Parallel Ports
- ✧ Projection TV
- ✧ Notebooks, Desktops, Server
- ✧ USB 1.1/2.0/3.0/3.1/OTG

### ● Mechanical data

- ✧ Lead finish:100% matte Sn(Tin)
- ✧ Mounting position: Any
- ✧ Qualified max reflow temperature:260 $^{\circ}\text{C}$
- ✧ Device meets MSL 1 requirements
- ✧ Pure tin plating: 7 ~ 17  $\mu\text{m}$



# SSCT24V11L2

## ● Electronic Parameter

Symbol	Parameter
$V_{RWM}$	Peak Reverse Working Voltage
$I_R$	Reverse Leakage Current @ $V_{RWM}$
$V_{BR}$	Breakdown Voltage @ $I_T$
$I_T$	Test Current
$I_{PP}$	Maximum Reverse Peak Pulse Current
$V_C$	Clamping Voltage @ $I_{PP}$
$P_{PP}$	Peak Pulse Power
$C$	Junction Capacitance

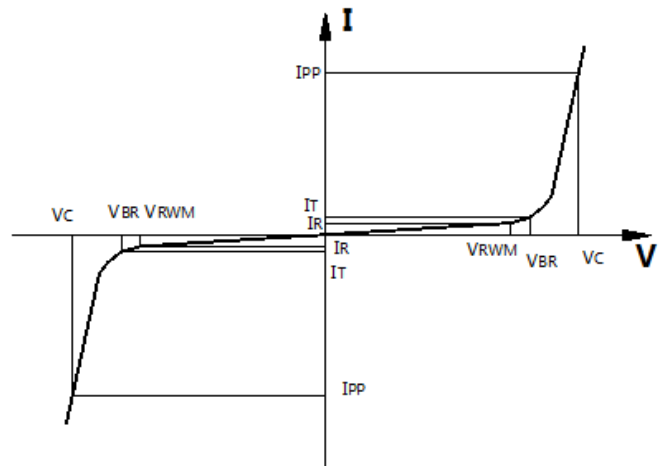

## ● Absolute maximum rating @TA=25°C

Symbol	Parameter	Value	Units
$P_{PP}$	Peak Pulse Power (8/20 $\mu$ S)	5500	W
$T_{STG}$	Storage Temperature	-55/+150	°C
$T_J$	Operating Temperature	-55/+150	°C

## ● Electrical Characteristics @TA=25°C

### SSCT24V11L2

Parameter	Symbol	Conditions	Min.	Typ.	Max.	Units
Peak Reverse Working Voltage	$V_{RWM}$	Any I/O to Ground		24		V
Breakdown Voltage	$V_{BR}$	$I_T = 1\text{mA}$ Any I/O to Ground	25			V
Reverse Leakage Current	$I_R$	$V_{RWM} = 12\text{V}$ , $T = 25^\circ\text{C}$			1	$\mu\text{A}$
Clamping Voltage	$V_C$	$I_{PP} = 50\text{A}$ , $t_P = 8/20\mu\text{s}$		26		V
Clamping Voltage	$V_C$	$I_{PP} = 170\text{A}$ , $t_P = 8/20\mu\text{s}$		29	30	V
Junction Capacitance	$C_J$	$V_R = 0\text{V}$ , $f = 1\text{MHz}$ , any I/O pin to Ground		0.74		nF
$P_{pp}$	Peak Pulse Power	$t_p = 8/20\mu\text{s}$ waveform		5500		W



# SSCT24V11L2

## ● Typical Performance Characteristics

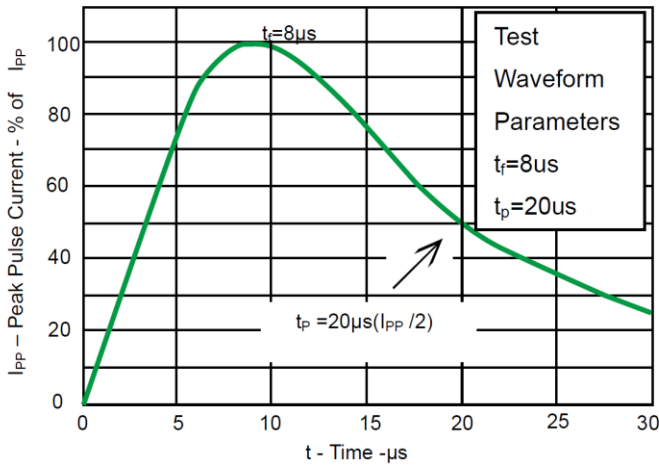

Fig 1. Pulse Waveform

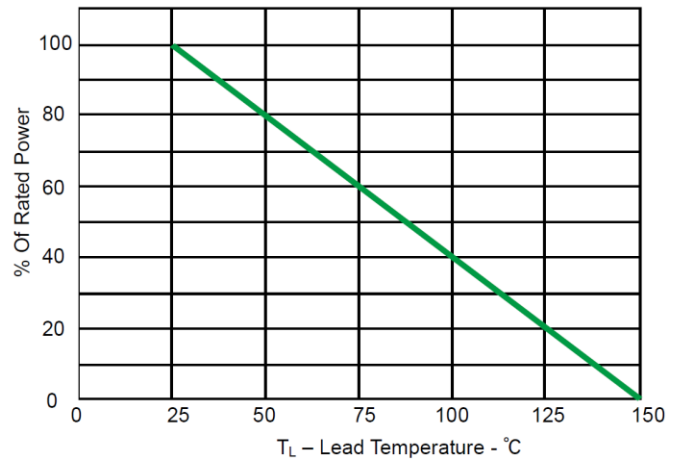
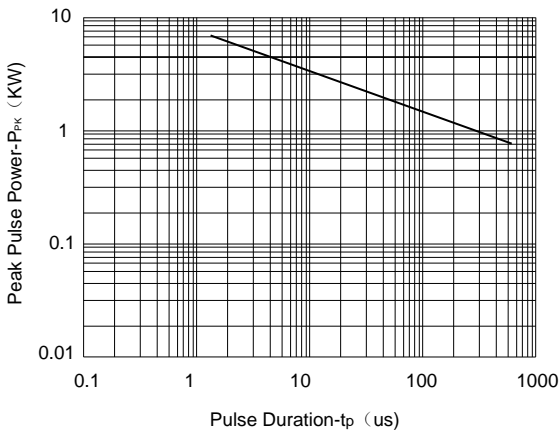

Fig 2. Power Derating Curve



### Non-Repetitive Peak Pulse Power vs. Pulse Time

## ● Solder Reflow Recommendation

Peak Temp=257°C, Ramp Rate=0.802deg. °C/sec

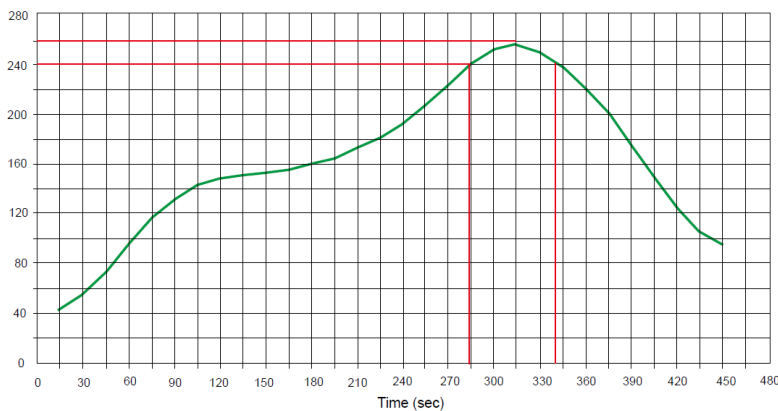



# SSCT24V11L2

- Package Information

## Ordering Information

Device	Package	Qty per Reel	Reel Size
SSCE24V11L2	DFN2020-3	10000	7 Inch

## Mechanical Data

Case: DFN2020-3

Case Material: Molded Plastic. UL Flammability

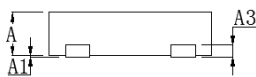
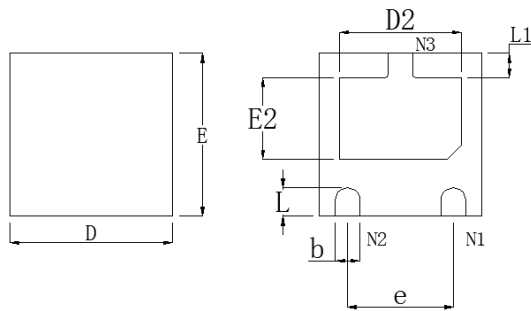

DIM	Millimeters		
	Min	Nom	Max
A	0.50	0.55	0.60
A1	0.00	-	0.05
A3	0.15 REF.		
D	1.95	2.00	2.05
E	1.95	2.00	2.05
b	0.25	0.30	0.35
L	0.30	0.35	0.40
L1	0.25	0.30	0.35
D2	1.35	1.50	1.60
E2	0.85	1.00	1.10
e	1.30 BSC		

## Recommended Pad outline

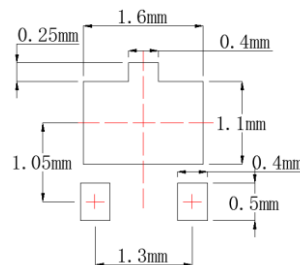



# SSCT24V11L2

---

## DISCLAIMER

AFSEMI RESERVES THE RIGHT TO MAKE CHANGES WITHOUT FURTHER NOTICE TO ANY PRODUCTS HEREIN TO IMPROVE RELIABILITY, FUNCTION OR DESIGN. AFSEMI DOES NOT ASSUME ANY LIABILITY ARISING OUT OF THE APPLICATION OR USE OF ANY PRODUCT OR CIRCUIT DESCRIBED HEREIN; NEITHER DOES IT CONVEY ANY LICIENCE UNDER ITS PATENT RIGHTS, NOR THE RIGHTS OF OTHERS.

THE GRAPHS PROVIDED IN THIS DOCUMENT ARE STATISTICAL SUMMARIES BASED ON A LIMITED NUMBER OF SAMPLES AND ARE PROVIDED FOR INFORMATIONAL PURPOSE ONLY. THE PERFORMANCE CHARACTERISTICS LISTED IN THEM ARE NOT TESTED OR GUARANTEED. IN SOME GRAPHS, THE DATA PRESENTED MAY BE OUTSIDE THE SPECIFIED OPERATING RANGE (E.G., OUTSIDE SPECIFIED POWER SUPPLY RANGE ) AND THEREFORE OUTSIDE THE WARRANTED RANGE.