



SSCE7V011N1

SSCE7V011N1

Ultra-low Capacitance Unidirectional Micro Packaged TVS Diodes for ESD Protection

● Description

The SSCE7V011N1 is designed with Punch-Through process TVS technology to protect voltage sensitive components from ESD. Excellent clamping capability, low leakage, and fast response time provide best in class protection on designs that are exposed to ESD. Because of its small size, it is suited for use in cellular phones, MP3 players, digital cameras and many other portable applications where board space comes at a premium. Also because of its low capacitance, it is suited for use in high frequency designs such as USB 2.0 high speed, USB 3.0 super speed, VGA, DVI, HDMI, eSATA and other high speed line applications.

● Feature

- ✧ 110W peak pulse power ($T_p = 8/20\mu s$)
- ✧ DFN1006 Package
- ✧ Working voltage: 7V
- ✧ Low clamping voltage
- ✧ Low capacitance
- ✧ RoHS compliant transient protection for high speed data lines to IEC61000-4-2(ESD) $\pm 30kV$ (air), $\pm 30kV$ (contact)

● PIN configuration

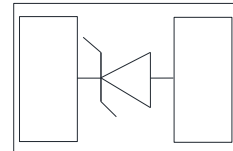

Topview

● Applications

- ✧ DVI & HDMI Port Protection
- ✧ Serial and Parallel Ports
- ✧ Projection TV
- ✧ Notebooks, Desktops, Servers
- ✧ Solid-state Punch-Through TVS Process technology Portable instrumentation

● Mechanical data

- ✧ Lead finish: 100% matte Sn(Tin)
- ✧ Mounting position: Any
- ✧ Qualified max reflow temperature: 260°C
- ✧ Device meets MSL 1 requirements
- ✧ Pure tin plating: 7 ~ 17 μm
- ✧ Pin flatness: $\leq 3mil$



SSCE7V011N1

● Electronic Parameter

Symbol	Parameter
V_{RWM}	Peak Reverse Working Voltage
I_R	Reverse Leakage Current @ V_{RWM}
V_{BR}	Breakdown Voltage @ I_T
I_T	Test Current
I_{PP}	Maximum Reverse Peak Pulse Current
V_C	Clamping Voltage @ I_{PP}
P_{PP}	Peak Pulse Power
C	Junction Capacitance

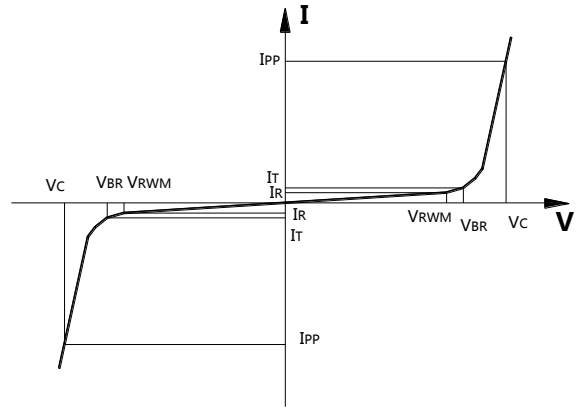

● Absolute maximum rating @TA=25°C

Symbol	Parameter	Value	Units
P_{PP}	Peak Pulse Power (8/20 μ S)	110	W
T_{STG}	Storage Temperature	-55/+150	°C
T_J	Operating Temperature	-55/+150	°C

● Electrical Characteristics @TA=25°C

Parameter	Symbol	Conditions	Min.	Typ.	Max.	Units
Peak Reverse Working Voltage	V_{RWM}				7	V
Breakdown Voltage	V_{BR}	$I_T = 1\text{mA}$	7.5		9.5	V
Reverse Leakage Current	I_R	$V_{RWM} = 5.0\text{V}, T = 25^\circ\text{C}$		0.1	1	μA
Clamping Voltage	V_C	$I_{PP} = 5\text{A}, T_P = 8/20\mu\text{s}$			10.6	V
		$I_{PP} = 24\text{A}, T_P = 8/20\mu\text{s}$			14.4	V
Junction Capacitance	C_J	$V_R = 0\text{V}, f = 1\text{MHz}$		4		pF



- **Typical Performance Characteristics**

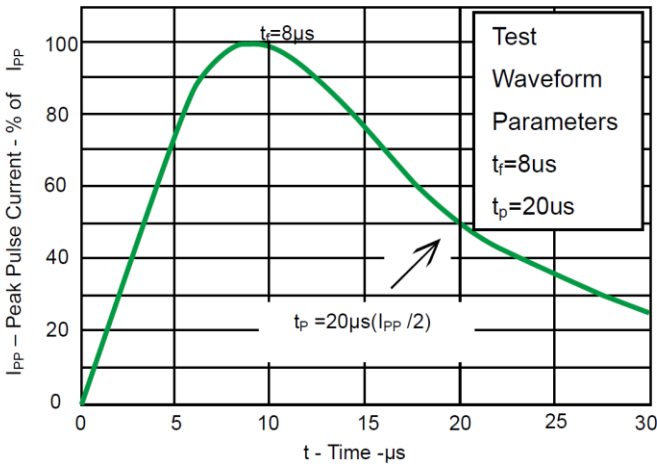

Fig 1. Pulse Waveform

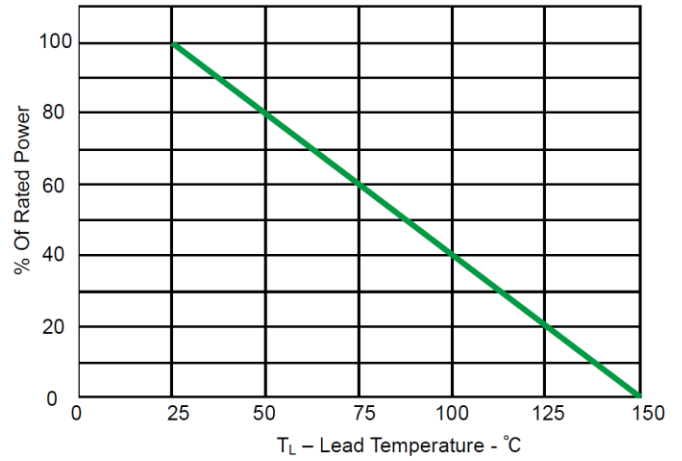
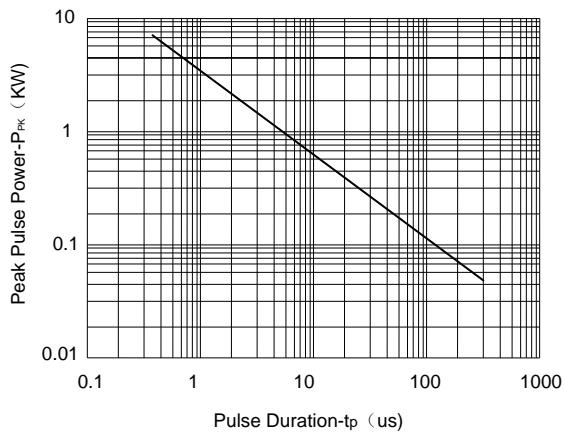

Fig 2. Power Derating Curve



Non-Repetitive Peak Pulse Power vs. Pulse Time



SSCE7V011N1

- **Solder Reflow Recommendation**

Peak Temp=257°C, Ramp Rate=0.802deg. °C/sec

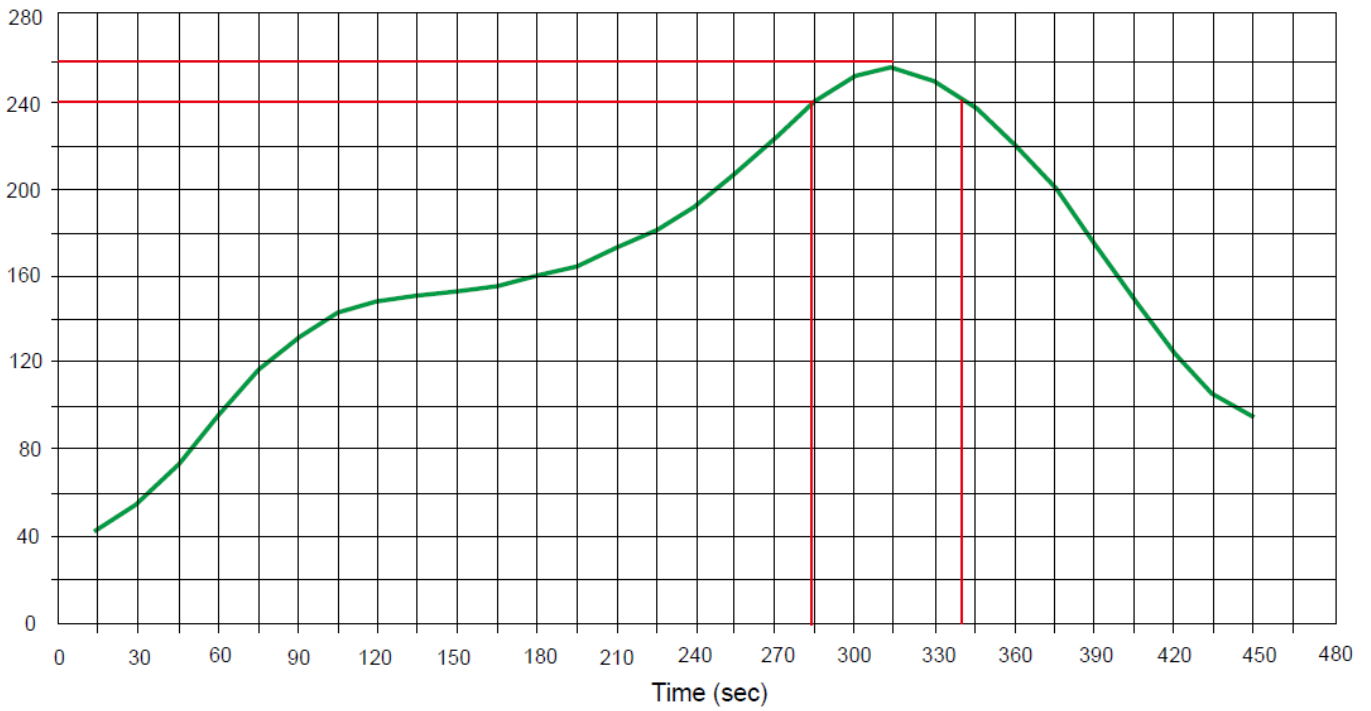



SSCE7V011N1

● Package Information

Ordering Information

Device	Package	Qty per Reel	Reel Size
SSCE7V011N1	DFN1006	10000	7 Inch

Mechanical Data

Case:DFN1006

Case Material: Molded Plastic. UL Flammability

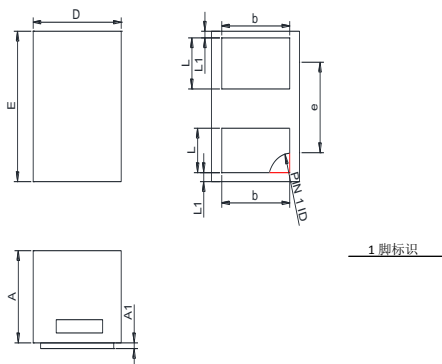

DIM	Millimeters	
	Min	Max
A	0.30	0.50
A1	0.00	0.05
D	0.55	0.65
E	0.95	1.05
b	0.25	0.60
e	0.65TYP	
L	0.15	0.35
L1	0.05REF	

Recommended Pad outline

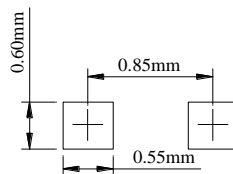

DISCLAIMER

AFSEMI RESERVES THE RIGHT TO MAKE CHANGES WITHOUT FURTHER NOTICE TO ANY PRODUCTS HEREIN TO IMPROVE RELIABILITY, FUNCTION OR DESIGN. AFSEMI DOES NOT ASSUME ANY LIABILITY ARISING OUT OF THE APPLICATION OR USE OF ANY PRODUCT OR CIRCUIT DESCRIBED HEREIN; NEITHER DOES IT CONVEY ANY LICIENCE UNDER ITS PATENT RIGHTS, NOR THE RIGHTS OF OTHERS.

THE GRAPHS PROVIDED IN THIS DOCUMENT ARE STATISTICAL SUMMARIES BASED ON A LIMITED NUMBER OF SAMPLES AND ARE PROVIDED FOR INFORMATIONAL PURPOSE ONLY. THE PERFORMANCE CHARACTERISTICS LISTED IN THEM ARE NOT TESTED OR GUARANTEED. IN SOME GRAPHS, THE DATA PRESENTED MAY BE OUTSIDE THE SPECIFIED OPERATING RANGE (E.G., OUTSIDE SPECIFIED POWER SUPPLY RANGE) AND THEREFORE OUTSIDE THE WARRANTED RANGE.