

SSC8P22AN3
N-Channel Enhancement Mode MOSFET with PNP Transistor

 ➤ **Features**
N-Channel

VDS	VGS	RDSON Typ.	ID
20V	±8V	255mR@4V5	0.8A
		390mR@2V5	

PNP Transistor

VCE	VBE	VCESAT Typ.	IC
-40V	-6V	-150mV	-3A

 ➤ **Pin configuration**

Top view

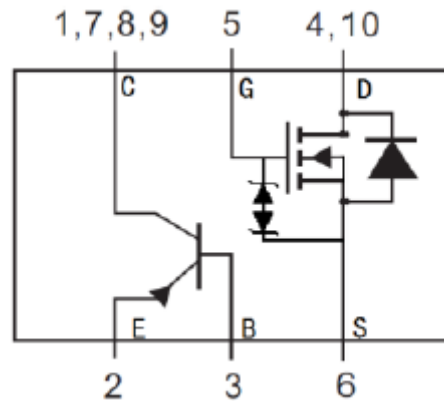
 ➤ **Description**

SSC8P22AN3 combines an N-Channel enhancement mode power MOSFET which is produced with high cell density and a Media Power PNP Transistor. The tiny and thin outline saves PCB consumption.

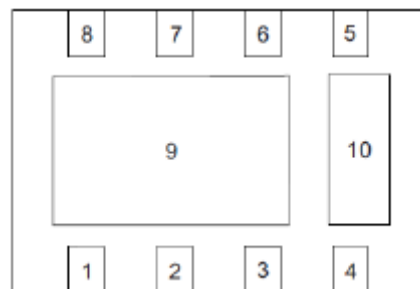

Bottom View

 ➤ **Applications**

- Li-Battery Charging

 ➤ **Ordering Information**

Device	Package	Shipping
SSC8P22AN3	DFN3X2	3000/Reel

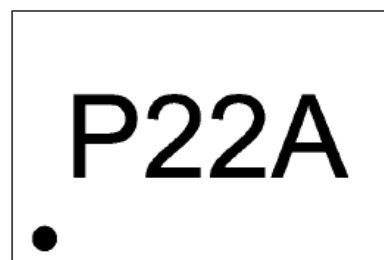

Marking

➤ **Absolute Maximum Ratings**($T_A=25^{\circ}\text{C}$ unless otherwise noted)

Symbol	Parameter	N-Channel	Unit
N-MOS			
V_{DSS}	Drain-to-Source Voltage	20	V
V_{GSS}	Gate-to-Source Voltage	± 8	V
I_D	Continuous Drain Current	0.8	A
I_{DM}	Pulsed Drain Current	3	A
PNP Transistor			
V_{CBO}	Collector-Base Voltage	-40	V
V_{CEO}	Collector-Emitter Voltage	-40	V
V_{EBO}	Emitter-Base Voltage	-6	V
I_C	Collector Current	-3	A
I_{CM}	Pulsed Collector Current	-6	A
Power Dissipation and Temperature			
P_D	Power Dissipation	3	W
T_A	Operation Temperature Range	-40 to 85	$^{\circ}\text{C}$
T_L	Lead Temperature	260	$^{\circ}\text{C}$
T_J	Operation junction temperature	-55 to 150	$^{\circ}\text{C}$
T_{STG}	Storage temperature range	-55 to 150	$^{\circ}\text{C}$

➤ **Thermal Resistance Ratings**($T_A=25^{\circ}\text{C}$ unless otherwise noted)

Symbol	Parameter	Value	Unit
$R_{\theta JA}$	Junction-to-Ambient Thermal Resistance	45	$^{\circ}\text{C}/\text{W}$

➤ **Electronics Characteristics**($T_A=25^{\circ}\text{C}$ unless otherwise noted)

Symbol	Parameter	Test Conditions	Min	Typ.	Max	Unit
N-Channel Enhancement Mode MOSFET						
$V_{(BR)DSS}$	Drain-Source Breakdown Voltage	$V_{GS}=0V, I_D=250\mu A$	20			V
$V_{GS(th)}$	Gate Threshold Voltage	$V_{DS}=V_{GS}, I_D=250\mu A$	0.35	0.6	1	V
$R_{DS(on)}$	Drain-Source On- Resistance	$V_{GS}=4.5V, I_D=0.5A$		255	450	mR
		$V_{GS}=2.5V, I_D=0.5A$		390	765	
		$V_{GS}=1.8V, I_D=0.35A$		520	850	
I_{DSS}	Zero Gate Voltage Drain Current	$V_{DS}=16V, V_{GS}=0V$			1	μA
I_{GSS}	Gate-Source leak current	$V_{GS}=\pm 12V, V_{DS}=0V$			± 10	μA
V_{SD}	Forward Voltage	$V_{GS}=0V, I_S=0.1A$		1	1.3	V
C_{iss}	Input Capacitance	$V_{DS}=16V, V_{GS}=0V,$ $F=200KHZ$		130		pF
C_{oss}	Output Capacitance			20		
C_{rss}	Reverse Transfer Capacitance			16		
$T_{D(ON)}$	Turn-on delay time	$V_{DS}=6V, V_{GS}=4.5V,$ $R_L=6R, R_G=6R, I_D=1A$		6		ns
$T_{D(OFF)}$	Turn-off delay time			42		

Symbol	Parameter	Test Conditions	Min	Typ.	Max	Unit
PNP Transistor						
BVCBO	Collector-Base Breakdown Voltage	IC= -50uA IE=0	-40			V
BVCEO	Collector-Emitter Breakdown Voltage	IC= -1mA IB=0	-40			V
BVEBO	Emitter-Base Breakdown Voltage	IE= -50uA IC=0	-6			V
ICBO	Collector cut off current	VCB= -20V IE=0			-0.1	uA
IEBO	Emitter cut off current	VEB= -4V IC=0			-0.1	uA
HFE	DC Current Gain	VCE= -2V IC= -0.5A	100		350	
VCESAT	Collector-Emitter Saturation Voltage	IC= -0.8A IB= -80mA		-0.15	-0.2	V
VBESAT	Base-Emitter Saturation Voltage	IC= -0.8A IB= -80mA			-1.2	V
f _T	Transition frequency	VCE= -6V, IE= -0.02A f=30MHz	50	80		Hz

➤ **N-Channel Typical Characteristics**($T_A=25^\circ\text{C}$ unless otherwise noted)

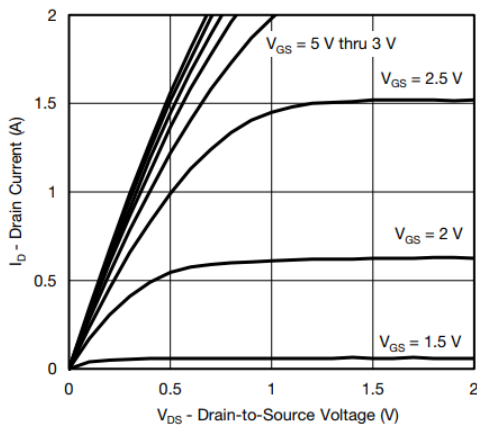

Output Characteristics

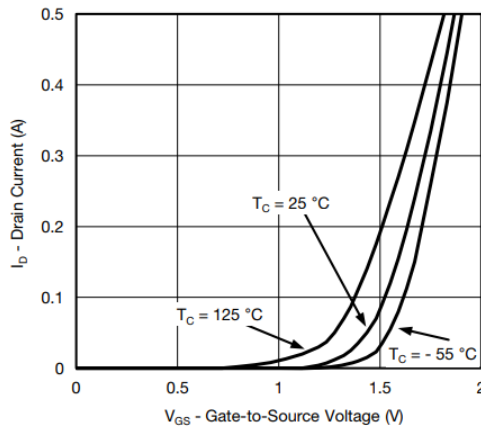

Transfer Characteristics

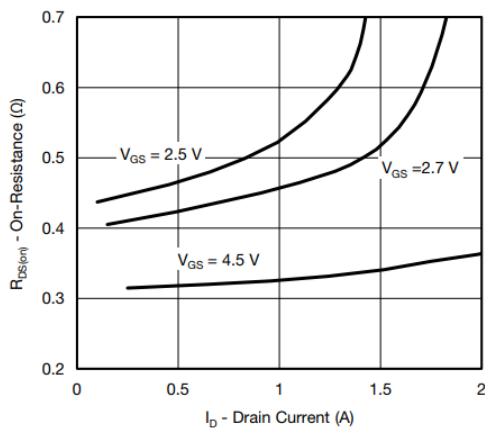

On-Resistance vs. Drain Current and Gate Voltage

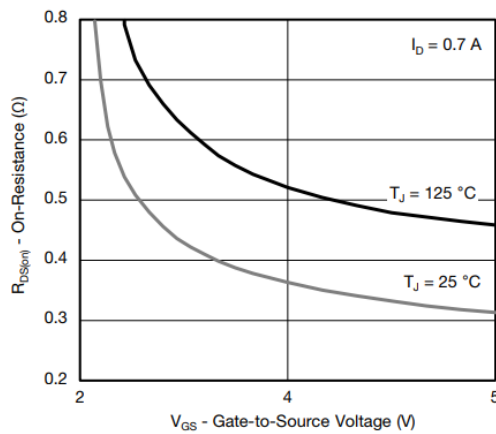

On-Resistance vs. Gate-to-Source Voltage

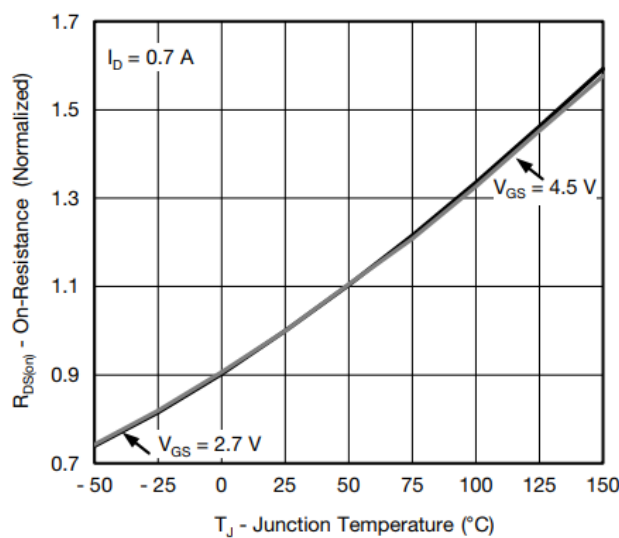

On-Resistance vs. Junction Temperature

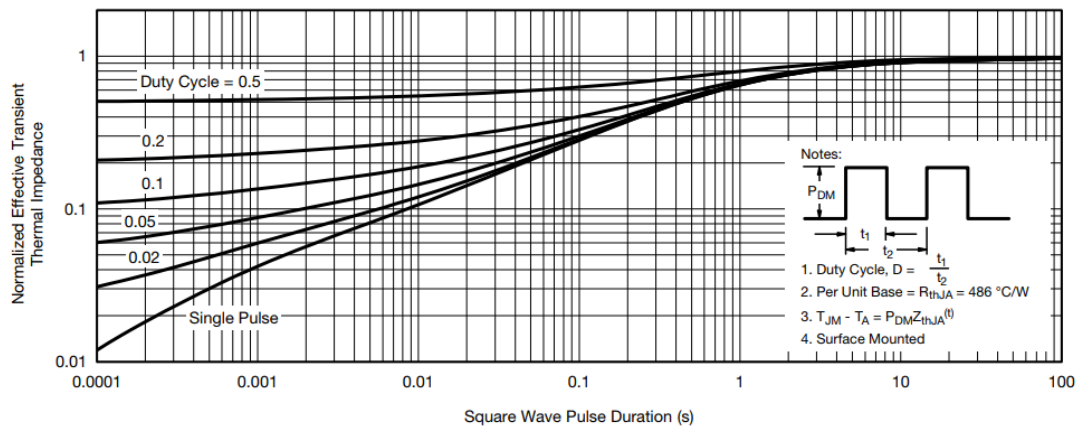

Normalized Thermal Transient Impedance, Junction-to-Ambient

➤ PNP Transistor Typical Performance Characteristics

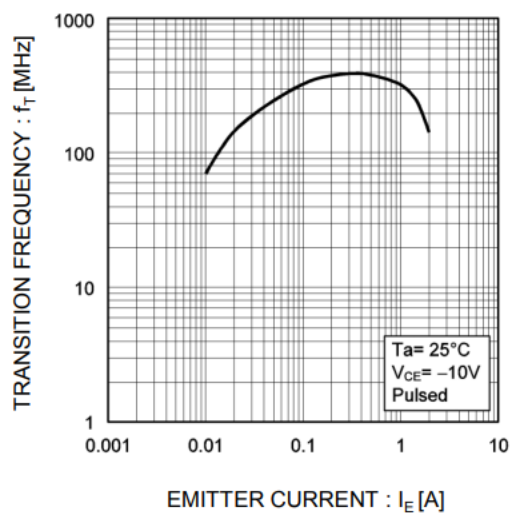
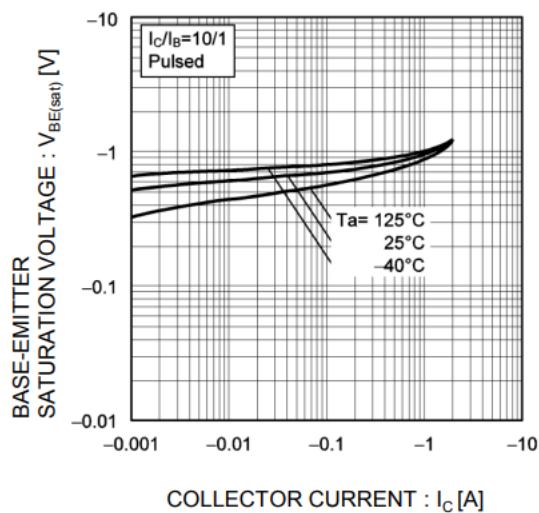
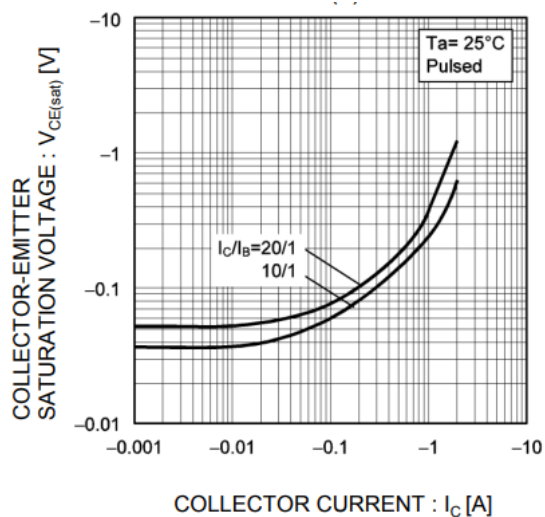
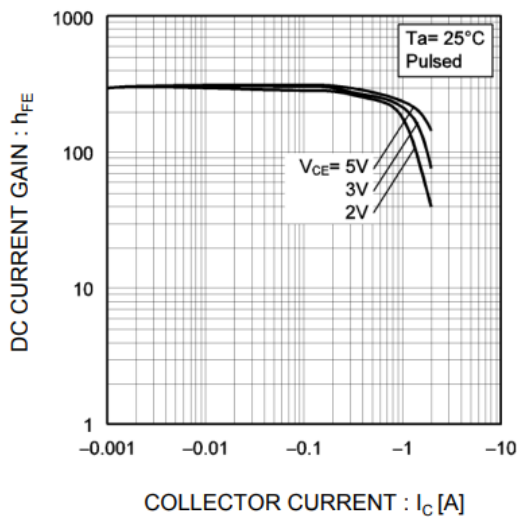
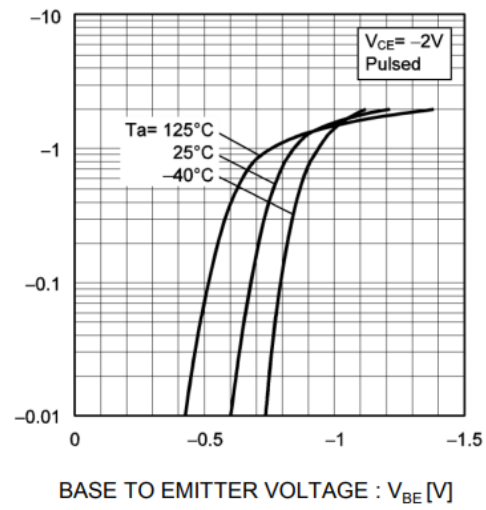
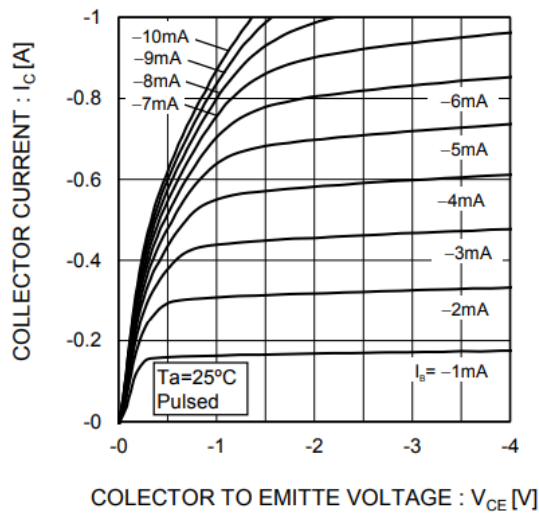

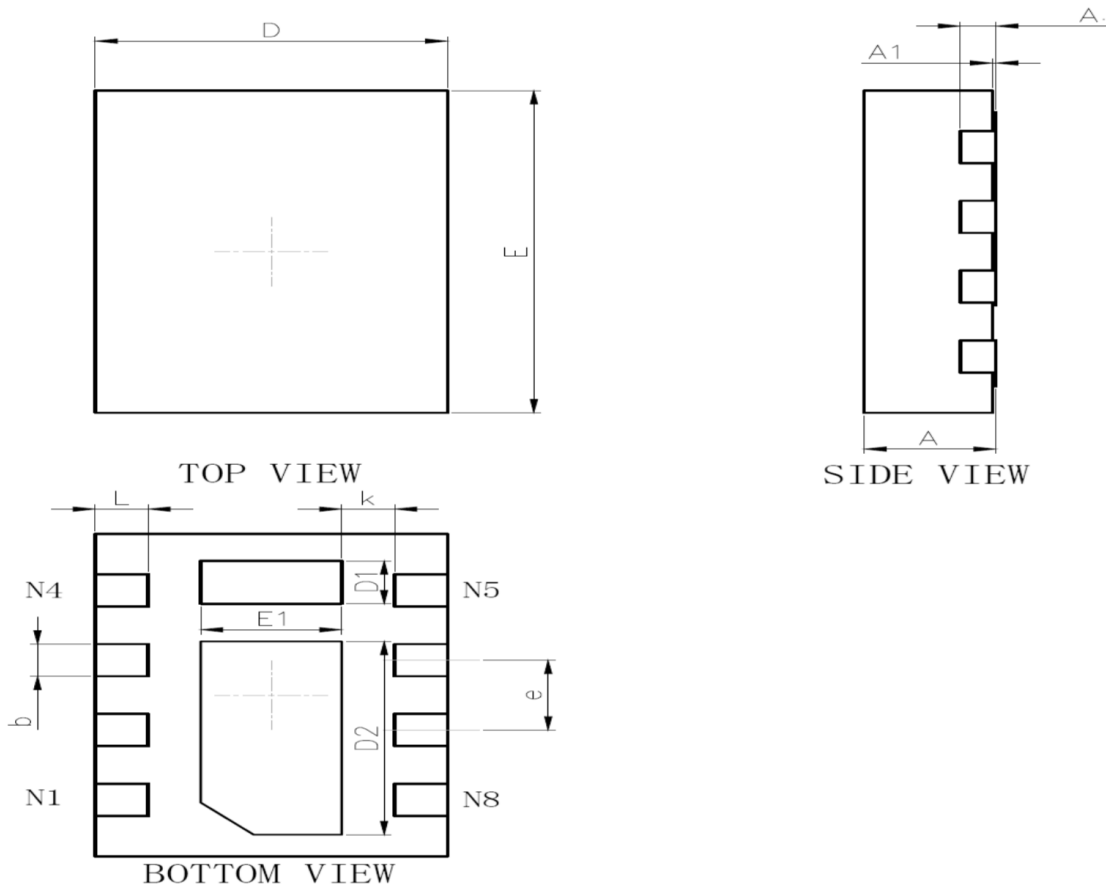
➤ Package Information

DFN3X2-8L

Symbol	Dimensions in millimeter	
	MIN.	MAX.
A	0.700	0.800
A1	0.000	0.050
A3	0.203REF.	
D	1.900	2.100
E	2.900	3.100
D1	0.300	0.500
E1	0.700	0.900
D2	1.700	1.900
b	0.250	0.350
e	0.650TYP.	
k	0.200MIN.	
L	0.250	0.350



DISCLAIMER

AFSEMI RESERVES THE RIGHT TO MAKE CHANGES WITHOUT FURTHER NOTICE TO ANY PRODUCTS HEREIN TO IMPROVE RELIABILITY, FUNCTION OR DESIGN. AFSEMI DOES NOT ASSUME ANY LIABILITY ARISING OUT OF THE APPLICATION OR USE OF ANY PRODUCT OR CIRCUIT DESCRIBED HEREIN; NEITHER DOES IT CONVEY ANY LICIENCE UNDER ITS PATENT RIGHTS, NOR THE RIGHTS OF OTHERS.

THE GRAPHS PROVIDED IN THIS DOCUMENT ARE STATISTICAL SUMMARIES BASED ON A LIMITED NUMBER OF SAMPLES AND ARE PROVIDED FOR INFORMATIONAL PURPOSE ONLY. THE PERFORMANCE CHARACTERISTICS LISTED IN THEM ARE NOT TESTED OR GUARANTEED. IN SOME GRAPHS, THE DATA PRESENTED MAY BE OUTSIDE THE SPECIFIED OPERATING RANGE (E.G. OUTSIDE SPECIFIED POWER SUPPLY RANGE) AND THEREFORE OUTSIDE THE WARRANTED RANGE.